



DESIGN SECURITY DOORS

PORTE CHE SI CHIUDONO PER APRIRSI VERSO MONDI
E LUOGHI INTIMI, VERSO SPAZI CHE VUOI VIVERE
E RITROVARE. LE PORTE ALIAS PROTEGGONO LA TUA
IDEA DI CASA, IL TUO SPAZIO E, ESATTAMENTE COME
VUOI TU, COSTITUISCONO IL TUO STILE. PERCHÉ ALIAS
È SICUREZZA INSIDE, DESIGN OUTSIDE.

Doors that close to open towards worlds and intimate places, towards spaces you want to live in and to find again. Alias doors protect your home idea, your place and represent your style, as you want, because Alias is security inside, design outside.

“Behind each door there is a unique and unrepeatable story: a family, boys, kids who grow up, timeless emotions and small everyday details. These are the stories that inspire our job, always beyond the quality sill, always ready to innovate”.

Dario Vaccari, President ALIAS Srl

Puertas que se cierran para abrirse hacia mundos y lugares íntimos, hacia espacios que te gustaría vivir y reencontrar. Las puertas Alias protegen tu idea de casa y, exactamente como a ti te gusta, constituyendo tu estilo. Porque Alias es seguridad dentro y diseño por fuera.

“Detrás de cada puerta hay una historia, única e irrepetible: una familia, jóvenes, niños que crecen, emociones inolvidables y pequeños detalles cotidianos. Éstas son las historias que inspiran nuestro trabajo, siempre más allá del umbral de calidad, siempre dispuestos a innovar”.

Dario Vaccari, Presidente ALIAS Srl

**“DIETRO OGNI PORTA C'È UNA STORIA,
UNICA E IRREPETIBILE: UNA FAMIGLIA,
DEI RAGAZZI, DEI BAMBINI CHE CRESCONO,
EMOZIONI SENZA TEMPO E PICCOLI
DETTAGLI QUOTIDIANI. SONO QUESTE
LE STORIE CHE ISPIRANO IL NOSTRO
LAVORO, SEMPRE OLTRE LA SOGLIA
DELLA QUALITÀ, SEMPRE PRONTI
ALL'INNOVAZIONE”**

DARIO VACCARI
PRESIDENTE ALIAS Srl

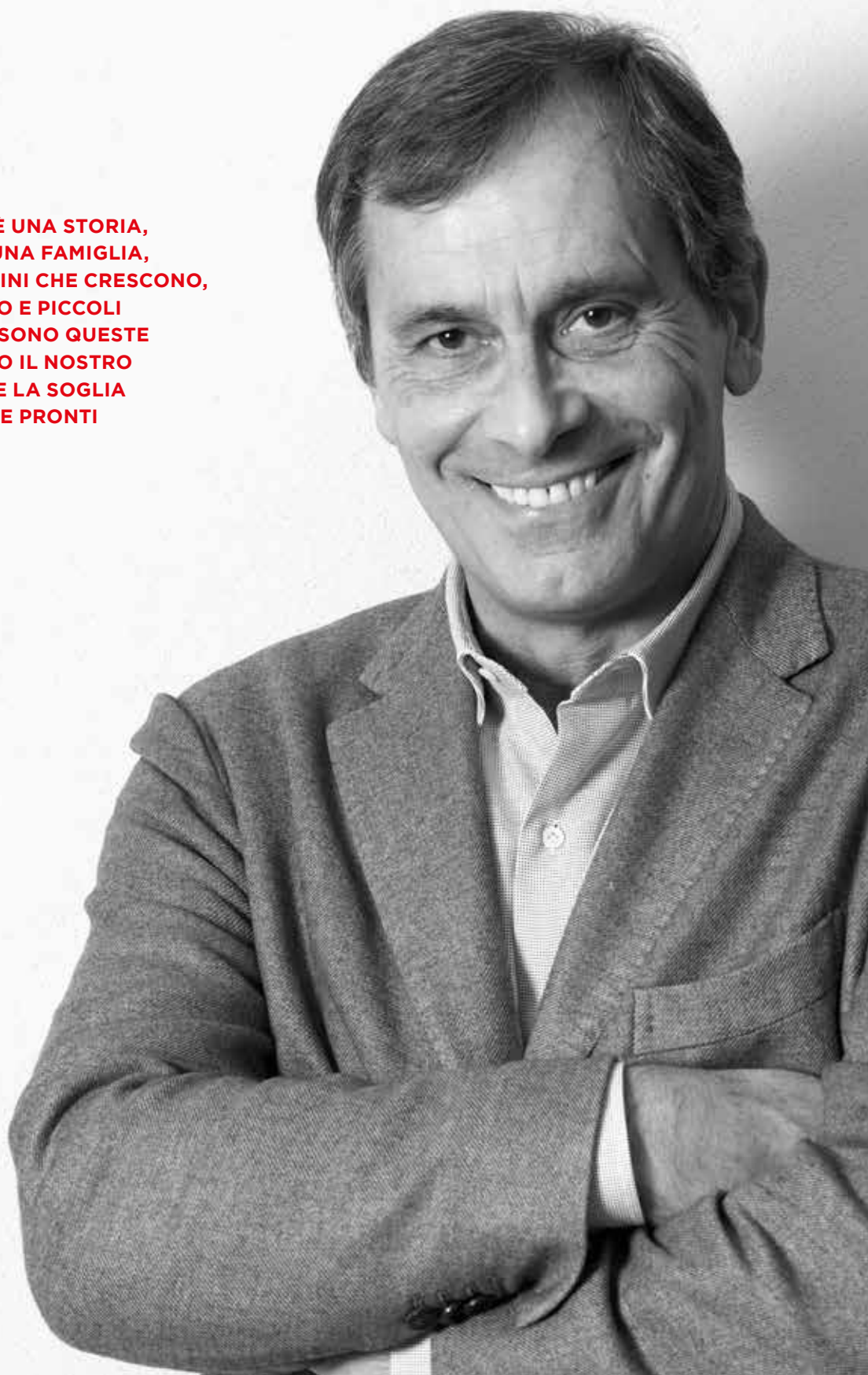



AS YOU LIVE.

SI DICE “PORTA BLINDATA” E SI PENSA A UN OGGETTO PESANTE, INGOMBRANTE, FUNZIONALE SÌ, MA PRIVO DI GRAZIA. LE DESIGN SECURITY DOORS DI ALIAS RIVOLUZIONANO L’ESTETICA DELLE PORTE BLINDATE, ANCHE GRAZIE ALLA VISIONE DEI NOSTRI DESIGNER E PROGETTISTI E ALLA LORO CONCEZIONE DI DESIGN DA VIVERE. OGNI CREAZIONE CONIUGA BELLEZZA, TECNOLOGIA E PERFORMANCE DANDO VITA A UN PRODOTTO ECCEZIONALE CAPACE DI CONFERIRE CARATTERE E ORIGINALITÀ A OGNI AMBIENTE.

When you talk about a security door, you think about a heavy, bulky object, functional but graceless. Alias Design Security Doors transform radically the aesthetic of security doors, thanks to our designers and engineers vision and their idea of design to live. Each product matches beauty, technology and performance creating an exceptional result that gives temper and originality to each place.

Se dice “puerta blindada” y se piensa a un objeto pesado, voluminoso, también funcional, pero sin gracia. Los diseños de las puertas de seguridad Alias revolucionan la estética de las puertas blindadas, también gracias a la visión de nuestros diseñadores y dibujantes, y a su concepción del arte de vivir. Cada creación conjuga belleza, tecnología y prestación dando vida a un producto excepcional capaz de dar carácter y originalidad a cada ambiente.



AS YOU LIKE.

PERFORMANCE, TECNOLOGIA, RESISTENZA: UNA PORTA DI SICUREZZA ALIAS È IL CONNUBIO TRA QUALITÀ E DESIGN. UN PRODOTTO PENSATO PER GARANTIRE PRESTAZIONI ECCELLENTI, DALL'EFFICACIA ANTIEFFRAZIONE ALL'ABBATTIMENTO ACUSTICO, TESTATO PER 50.000 APERTURE, L'EQUIVALENTE DI 30 ANNI DI SICUREZZA ASSOLUTA. L'INVIOLABILITÀ DELLA CASA È GARANTITA GRAZIE AD ABSOLUTE, LA RIVOLUZIONARIA CERNIERA A SCOMPARSA BREVETTATA DA ALIAS, PER PORTE ULTRAPIATTE, PENSATE COME PEZZI DI DESIGN, ELEMENTI D'ARREDO APERTI A OGNI ESIGENZA DI STILE.

Performance, technology, resistance: Alias Security Door is a perfect match between quality and design. A product projected to ensure excellent performance from anti-burglary efficacy to the acoustic abatement, tested for 50.000 openings, the equivalent of 30 years of absolute security. The inviolability of the house is granted by ABSOLUTE, the revolutionary hidden hinges, registered by Alias, for ultra-flat door, projected as design object, furniture elements opened to all style requests.

Prestación, tecnología, resistencia: una puerta de seguridad Alias es la combinación de calidad y diseño. Un producto pensado para garantizar excelentes rendimientos, desde la eficiencia antirrobo hasta la insonorización, demostrado por 50.000 aperturas, el equivalente a 30 años de seguridad absoluta. La invulnerabilidad de la casa está garantizada gracias y absolute, a la revolucionaria bisagra invisible patentada por Alias, para puertas ultra planas, pensadas como piezas de diseño, elementos de decoración abiertos a cada exigencia de estilo.

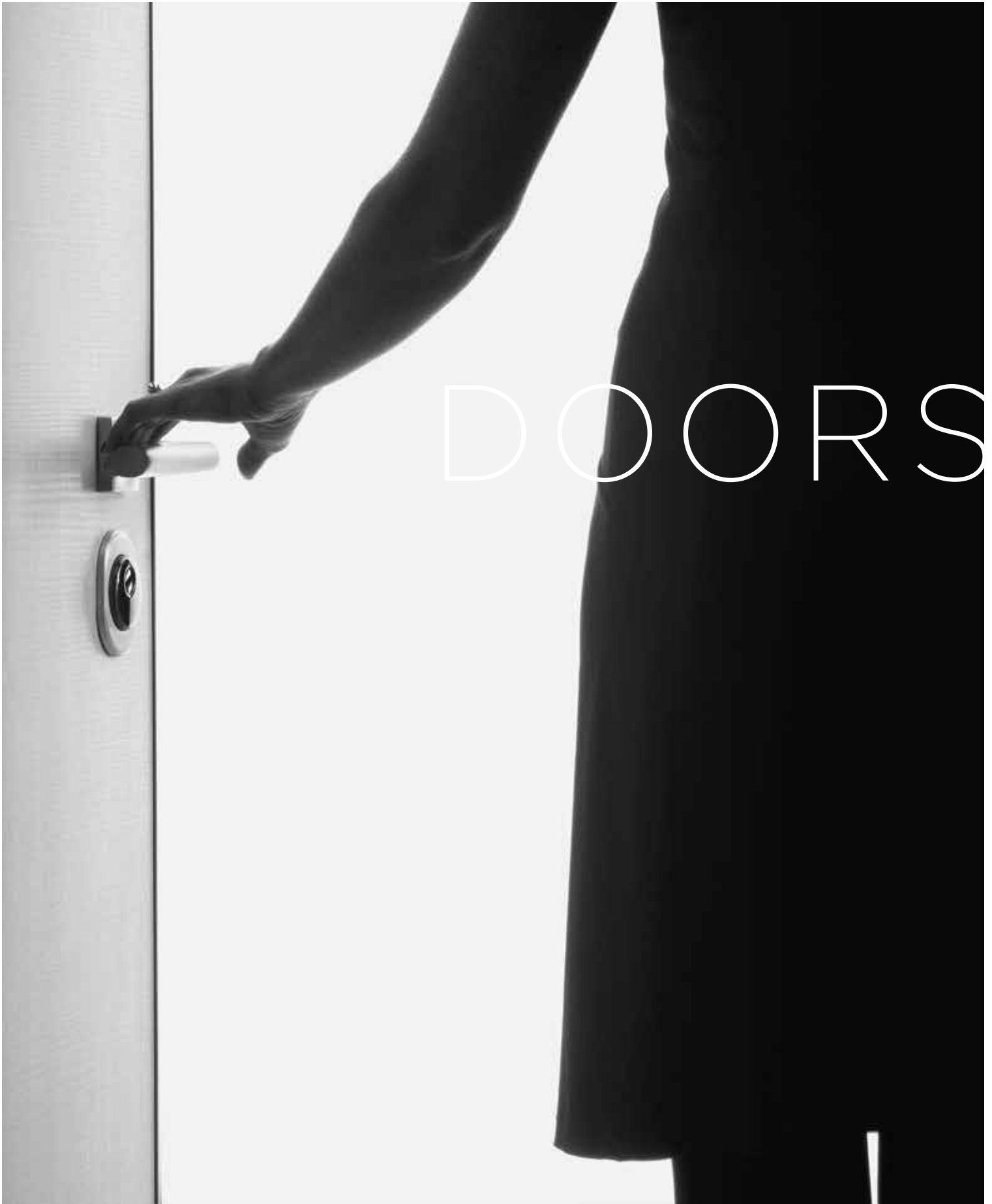

AS YOU ARE.

LA PORTA È LA PRIMA COSA CHE SI VEDE ENTRANDO IN UN NUOVO AMBIENTE, È L'INGRESSO E IL BENVENUTO. LE PORTE ALIAS ASSOMIGLIANO ALLA TUA IDEA DI ABITARE: TUTTI GLI INGRESSI BLINDATI DISPONGONO DI UN'AMPIA GAMMA DI FINITURE E RIVESTIMENTI, PANNELLI IN DIVERSI MATERIALI, CLASSICI COME IL LEGNO O INSOLITI COME IL GRÈS E LA PIETRA, MA ANCHE INSERTI IN ALLUMINIO E METALLO. UN BENVENUTO IN GRANDE STILE, IL TUO.

The door is the first thing that you see when you enter in a new place, it is the entrance, the welcome. Alias doors look like to your living idea. A wide range of finishing, panels are available for all security doors. Panels in different materials, classical as wood or unusual as gres or stone, but also aluminum, metal inserts. A stylish welcome, yours.

La puerta es la primera cosa que se percibe entrando en un nuevo ambiente, es el ingreso y el bienvenido. Las puertas Alias se asemejan a tu idea de hábitat: todos las puertas blindadas disponen de una amplia gama acabados y revestimientos, paneles de variados materiales, clásicos como la madera o inusuales como el gres o la piedra, pero también con insertos en aluminio y otros metales. Un bienvenido en gran estile, el tuyo.

INDICE

FLAT COLLECTION P. 12

CONTEMPORARY

QUADRANTE	P. 22
VERTIGO	P. 32
MOOD	P. 36
PLANAR	P. 40
BRERA	P. 44
MOUSE	P. 48
ONDA	P. 52
LINK	P. 56
CACTUS	P. 60
MAP	P. 64
NINE	P. 68
VELA	P. 72
OVAL	P. 76
TEN	P. 80
PAIS	P. 84
CARGO	P. 92
LISTEN	P. 96
IN OUT	P. 100
SQUARE	P. 104
LINEA	P. 108
AFORISMI	P. 112
MOTION	P. 116

TRADITION

BASIC	P. 122
BASIC LINE	P. 134
INTARSIO	P. 136
NATUR - ALL	P. 138
SKIPPER	P. 140
URBAN	P. 144
DIAMANTE	P. 146
FAST	P. 152
PRIMA CLASSE	P. 158
ETERN - ALL	P. 162
NAUTILUS	P. 168
RENO	P. 170

SHOWROOM

P. 174

STRUCTURES SYSTEM

STEEL	P. 178
STEEL PLUS	P. 180
VEGA PLUS	P. 182
STEEL C FB6	P. 184
DUO	P. 186
SILVER	P. 188
DOUBLE	P. 190
GOLD	P. 192
PLATINUM	P. 194
TITANIUM	P. 196
ZTL	P. 198
MAGMA/30	P. 200
MAGMA/60	P. 201
MAGMA/90	P. 202

OPTIONAL

P. 205

FLAT COLLECTION.

UN SISTEMA NATO PER RENDERE UNICO IL TUO AMBIENTE. CON LA COLLEZIONE FLAT, LO SPAZIO CONQUISTA UNA NUOVA DIMENSIONE DI DESIGN. LA PARTICOLARE STRUTTURA DELLA CARENATURA PERIMETRALE DELLA PORTA, DISPONIBILE PER SILVER, GOLD, PLATINUM E TITANIUM, PERMETTE INOLTRE UN ABBATTIMENTO DELLA TRASMITTANZA TERMICA FINO A UN VALORE DI 1,0 W/M² K. UN PRODOTTO UNICO, DAL CARATTERE INNOVATIVO E ORIGINALE E DALLA MASSIMA PERFORMANCE ISOLANTE.

A systems created to let your place unique. The space has a new design dimension with flat collection. The particular framework of the door profile, available for silver, gold, platinum and titanium, ensures also a reduction of thermic trasmittance till a value of 1,0 W/M² K. A unique product, with an innovative personality and with top insulation perfomances.

Un sistema creado para que tu ambiente sea inimitable. Con la colección flat, el espacio conquista una nueva dimensión de diseño. La especial estructura del carenado perimetral de la puerta, disponible en los tipos silver, gold, platinum y titanium, permite también una reducción de la transmitancia térmica hasta de 1,0 W/M² K. Un artículo único, de carácter innovador y original, y con las máximas prestaciones aislantes.



FLAT

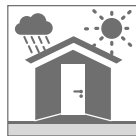

MODELLO FLAT IN ROVERE ORIZZONTALE TINTO MIELE.
MANIGLIA FENIX A ROSETTA QUADRA IN CROMO SATINATO.

Flat model in horizontal honey oak. Fenix handle with matt chrome squared support.

Modelo Flat en roble horizontal tenido miel. Manija Fenix con moseta cuadrada en satinado cromado.





FLAT





MODELLO FLAT IN LAMINATO LUCIDO RAL 3002. MANIGLIA FENIX A ROSETTA QUADRA IN CROMO SATINATO. (PERSONALIZZAZIONE CON CRISTALLI SU RICHIESTA).

Flat model with lacquered laminated panel RAL 3002. Fenix handle with matt chrome squared support. (Crystals available upon request).

Modelo Flat lacado brillante royo RAL 3002. Manija Fenix con roseta cuadrada en satinado cromado. (Personalización con cristales a petición).

FLAT





MODELLO FLAT INFINITY IN LAMINATO TRANCHÉ COLOR TERRA. MANIGLIA FENIX A ROSETTA QUADRA IN CROMO SATINATO.

Flat Infinity model in laminated earth tranché. Fenix handle with matt chrome squared support.

Modelo Flat Infinity en laminado bloqueado aspecto forma de la tierra traco. Manija Fenix con roseta cuadrada en satinado cromado.

CONTEMPORARY.

UNA LINEA SOLIDA CONTRADDISTINTA DAL DESIGN SUGGESTIVO E DA ACCOSTAMENTI DI MATERIALI INNOVATIVI E PREMIUM, PER DELIMITARE LO SPAZIO CON LO STILE CHE RISPECCHIA LA TUA PERSONALITÀ. LA LINEA CONTEMPORARY, ORIGINALE E RICERCATA IN OGNI SUO DETTAGLIO.

A solid line, featured by an evocative design and by innovative and premium material's combination, to outline the space that reflects your personality. Contemporary line, original and sophisticated in each detail.

Una línea sólida marcada por un diseño sugestivo y por combinación de materiales innovadores y con calidad suprema, para delimitar con el estilo que refleja tu personalidad. La línea Contemporánea, original y exigente en cada particular.



QUADRANTE

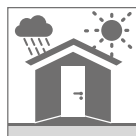

MODELLO QUADRANTE IN LAMINATO BIANCO MATRIX CON MODULO CENTRALE IN METACRILATO MOKA. MANIGLIA H4 A ROSETTA QUADRA IN CROMO SATINATO.

Quadrante model in laminated white Matrix with central module in methacrylate moka. H4 handle with matt chrome squared support.

Modelo Quadrante en laminado blanco Matrix con modulo central en metacrilato moka. Manija H4 con roseta cuadrada en cromo satinado.





QUADRANTE

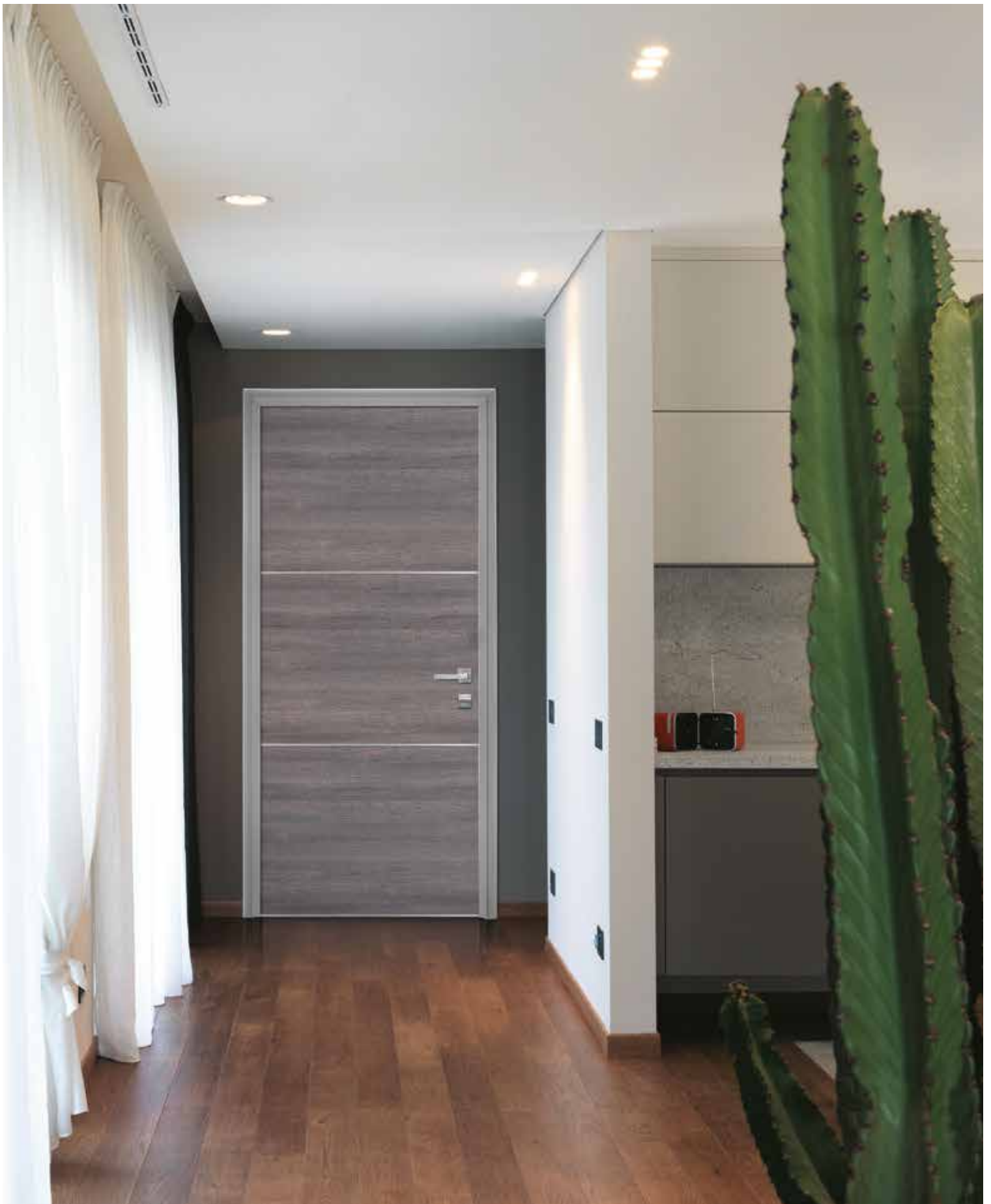



MODELLO QUADRANTE IN LAMINATO CENERE TRANCHÉ CON I TRE MODULI A VENATURA ORIZZONTALE. MANIGLIA H4 A ROSETTA QUADRA IN CROMO SATINATO.

Quadrante model in laminated cinder tranché with 3 modules with horizontal grain module. H4 handle with matt chrome squared support.

Modelo Quadrante color cenizas laminado tranché con los tres módulos en grano horizontal. Manija H4 con roseta cuadrada en satinado cromado.

QUADRANTE





MODELLO QUADRANTE IN LAMINATO CON MODULO SUPERIORE E INFERIORE GRIGIO MATRIX E MODULO CENTRALE BIANCO MATRIX. MANIGLIA H4 A ROSETTA QUADRA IN CROMO SATINATO COMPLETA DI POMOLO PER DISPOSITIVO BLOCK COORDINATO.

Quadrante laminated model with upper and bottom module in grey Matrix and central module in white Matrix. H4 handle with matt chrome squared support, complete with coordinated block device.

Modelo Quadrante laminado con módulo superior y inferior en Matrix color cenizo y modulo central en Matrix blanco. Manija H4 con roseta cuadrada en satinado cromado completo con perilla para el bloque de dispositivo.

QUADRANTE





MODELLO QUADRANTE IN METACRILATO NERO CON MODULO CENTRALE FACESTONE VULCANO. MANIGLIA H4 A ROSETTA QUADRA IN CROMO SATINATO COMPLETA DI POMOLO PER DISPOSITIVO BLOCK COORDINATO.

Quadrante model in black methacrylate with central module Facestone Vulcano. H4 handle with matt chrome squared support, complete with coordinated block device.

Modelo Quadrante en metacrilato negro con el centro del módulo en Facestone Volcán. Manija H4 con roseta cuadrada en satinado cromado completo con perilla para el bloque de el dispositivo coordinado.

QUADRANTE

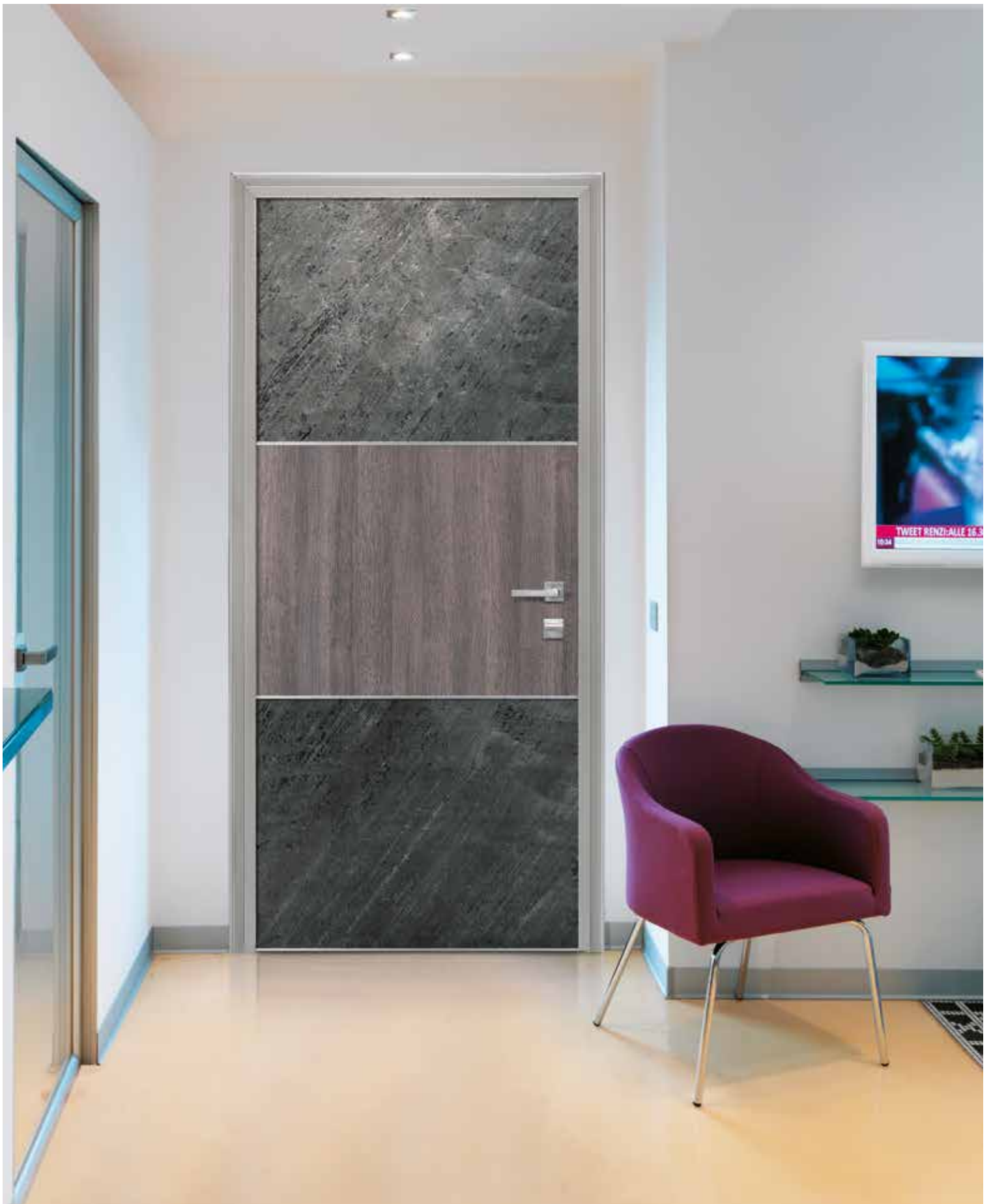



MODELLO QUADRANTE IN FACESTONE ARDESIA CON MODULO CENTRALE IN LAMINATO CENERE TRANCHÉ. MANIGLIA H4 A ROSETTA QUADRA IN CROMO SATINATO.

Quadrante model in Facestone Ardesia with central module in laminated ash tranché. H4 handle with matt chrome squared support.

Modelo Quadrante en Facestone Ardesia con modulo central en laminado color ceniza tranché. Manija H4 con roseta cuadrada en satinado cromado.

VERTIGO



MODELLO VERTIGO 1 COMPOSTO DA LAMINATO CENERE TRANCHÉ, BIANCO OPACO 9010, ROSSO RAL 3011 LUCIDO. MANIGLIA H4 A ROSETTA QUADRA IN CROMO SATINATO.

Vertigo 1 model is composed by laminated cinder tranché panel, opaque white RAL 9010 panel, brilliant red panel RAL 3011. H4 handle with matt chrome squared support.

Modelo Vertigo 1 se compone de un laminado color ceniza en tranché opaco blanco RAL 9010, y rojo RAL 3011 brillante. Manija H4 con roseta cuadrada en satinado cromado.





VERTIGO





MODELLO VERTIGO 2 COMPOSTO DA TRE MODULI IN LAMINATO BIANCO RAL 9010, WENGÉ E LACCATO RAL 1019. MANIGLIA H4 A ROSETTA QUADRA IN CROMO SATINATO.

Vertigo 2 is composed by 3 modules in laminated white RAL 9010, wengé and lacquered RAL 1019. H4 handle with matt chrome squared support.

Vertigo 2 modelo consta de tres módulos de laminado blanco RAL 9010, wengé y lacado RAL 1019. Manija H4 con roseta cuadrada en satinado cromado.

MOOD



MODELLO MOOD CON FASCE LATERALI GRIGIO MATRIX E CENTRALE BIANCO LUCIDO METACRILATO. MANIGLIA H4 A ROSETTA QUADRA IN CROMO SATINATO COMPLETA DI POMOLO PER DISPOSITIVO BLOCK COORDINATO.

Mood model with side strips grey Matrix and central brilliant white methacrylate panel. H4 handle with matt chrome squared support complete with coordinated block device.

Modelo Mood con bandas laterales gris Matrix y central de color blanco brillante en metacrilato. Manija H4 con roseta cuadrada en satinado cromado completo con perilla para el bloque de dispositivo.





MOOD





MODELLO MOOD CON FASCE LATERALI LACCATE NERO LUCIDO E CENTRALE IN WENGÉ. MANIGLIA H4 A ROSETTA QUADRA IN CROMO SATINATO COMPLETA DI POMOLO PER DISPOSITIVO BLOCK COORDINATO.

Mood model with brilliant black side strips and central wengé oak module. H4 handle with matt chrome squared support complete with coordinated block device.

Modelo Mood con paneles laterales de laca negra brillante y el centro en wengé. Manija H4 con roseta cuadrada en satinado cromado completo con perilla para el bloque de dispositivo.

PLANAR



MODELLO PLANAR LACCATO BIANCO LUCIDO, INSERTO CENTRALE FACESTONE VULCANO. MANIGLIA H4 A ROSETTA QUADRA IN CROMO SATINATO COMPLETA DI POMOLO PER DISPOSITIVO BLOCK COORDINATO.

Planar model brilliant white, central insert Facestone Vulcano. H4 handle with matt chrome squared support complete with coordinated block device.

Modelo Planar lacado blanco brillante, con inserción central Facestone Vulcan. Manija H4 con roseta cuadrada en satinado cromado completo con perilla para el bloque.





PLANAR





MODELLO PLANAR IN ROVERE VERTICALE COLOR PIETRA, INSERTO CENTRALE IN ACCIAIO INOX. MANIGLIA H4 A ROSETTA QUADRA IN CROMO SATINATO COMPLETA DI POMOLO PER DISPOSITIVO BLOCK COORDINATO.

Planar model in vertical grain oak stone color, central sheet insert. H4 handle with matt chrome squared support complete with coordinated block device.

Modelo Planar en roble vertical color piedra, insercion central en acero inoxidable. Manija H4 con roseta cuadrada en satinado cromado completo con perilla para el bloque.

BRERA

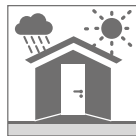

MODELLO BRERA IN ROVERE ORIZZONTALE COLOR TABACCO,
INSERTO CENTRALE FACESTONE VULCANO. MANIGLIA H4 A
ROSETTA QUADRA IN CROMO SATINATO.

Brera model in vertical oak tobacco color, central insert
Facestone Vulcano. H4 handle with matt chrome squared
support.

Modelo Brera en color roble horizontal tabaco, inserto central
Facestone Vulcan. Manija H4 con roseta cuadrada en satinado
cromado.





BRERA





MODELLO BRERA IN ROVERE VERTICALE COLOR TABACCO, INSERTO CENTRALE IN ACCIAIO INOX. MANIGLIA H4 A ROSETTA QUADRA IN CROMO SATINATO.

Brera model in vertical oak tobacco color, central sheet insert. H4 handle with matt chrome squared support.

Modelo Brera en color roble vertical tabacco, y insercion central en acero inoxidable. Manija H4 con roseta cuadrada en satinado cromado.

MOUSE



MODELLO MOUSE LACCATO BIANCO RAL 9010 CON MODULO CENTRALE IN LAMINATO PALISSANDRO MATRIX. MANIGLIA H4 A ROSETTA QUADRA IN CROMO SATINATO.

Mouse model laquered white RAL 9010 with central module in laminated Matrix rose oak. H4 handle with matt chrome squared support.

Modelo Mouse lacado blanco RAL 9010 con el módulo central en palisandro Matrix. Manija H4 con roseta cuadrada en satinado cromado.





MOUSE





MODELLO MOUSE LACCATO GRIGIO RAL 7045 CON MODULO CENTRALE IN LAMINATO SABBIA TRANCHÉ. MANIGLIA H4 A ROSETTA QUADRA IN CROMO SATINATO, COMPLETA DI POMOLO PER DISPOSITIVO BLOCK COORDINATO.

Mouse model lacquered grey RAL 7045 with central module in laminated sand tranché. H4 handle with matt chrome squared support, complete with coordinated block device.

Modelo Mouse lacado gris RAL 7045 laminado con módulo central color arena tranché. Manija H4 con roseta cuadrada en satinado cromado, completa con perilla para el bloque.

ONDA



MODELLO ONDA CON MODULO LATO CERNIERA LACCATO RAL 1019 E MODULO LATO SERRATURA IN LAMINATO GRIGIO MATRIX. MANIGLIA H4 A ROSETTA QUADRA IN CROMO SATINATO COMPLETA DI POMOLO PER DISPOSITIVO BLOCK COORDINATO.

Onda model with RAL 1019 module hinge side and laminated grey Matrix module lock side. H4 handle with matt chrome squared support complete with coordinated block device.

Modelo Onda con modulo lateral lado bisagra lacado RAL 1019 y laminado lado de la cerradura Matrix gris. Manija H4 con roseta cuadrada en satinado cromado completo con perilla para el bloque.

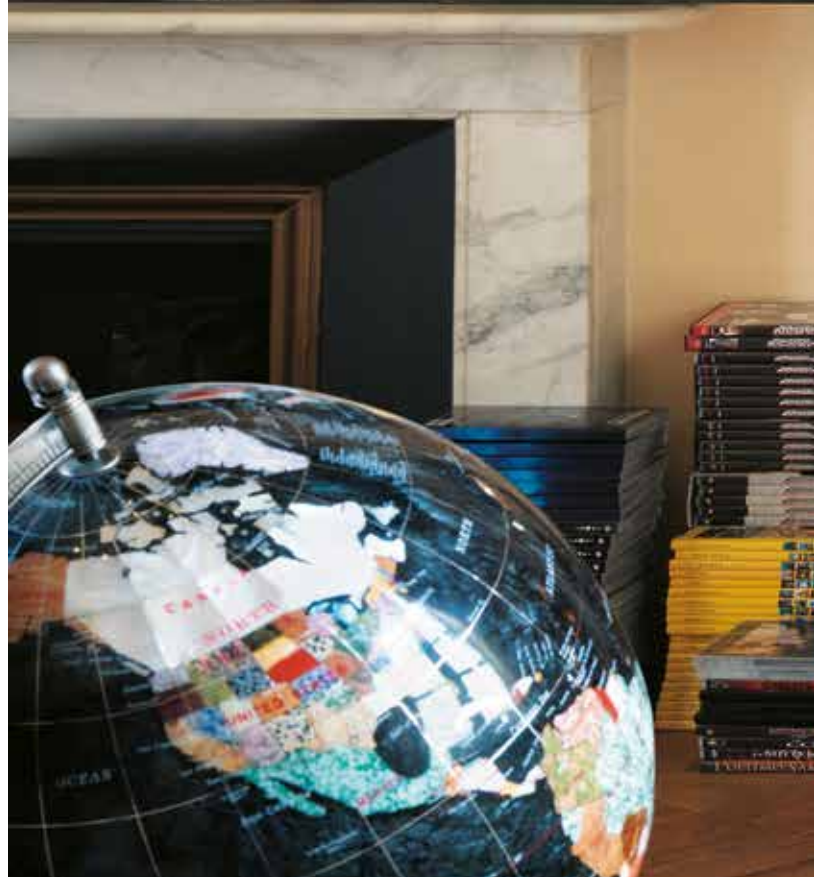
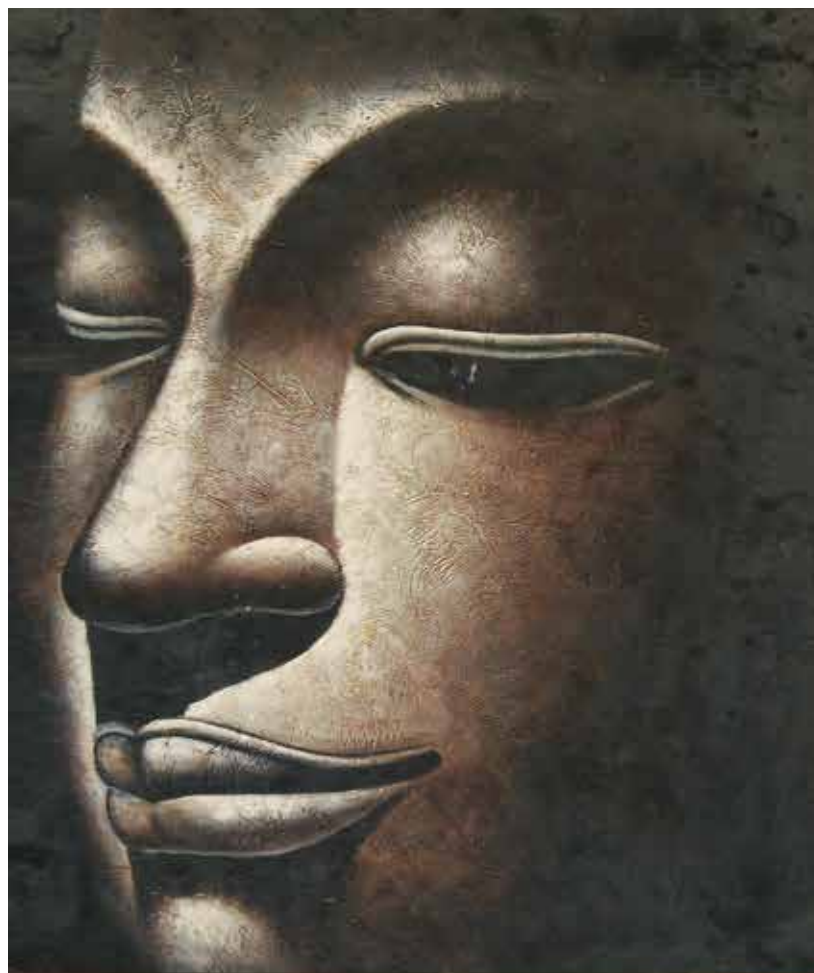







MODELLO ONDA CON MODULO LATO CERNIERA LACCATO BIANCO RAL 9010 E MODULO LATO SERRATURA IN LAMINATO TERRA TRANCHÉ. MANIGLIA H4 A ROSETTA QUADRA IN CROMO SATINATO COMPLETA DI POMOLO PER DISPOSITIVO BLOCK COORDINATO.

Onda model with hinge side RAL 9010 module and lock side with laminated earth Tranché module. H4 handle with matt chrome squared support complete with coordinated block device.

Modelo Onda con cremallera lateral lacado blanco RAL 9010 y laminado bloqueo aspecto forma de la tierra tramo. Manija H4 con roseta cuadrada en satinado cromado completo con perilla para el bloque.

LINK



MODELLO LINK TUTTO IN ROVERE ORIZZONTALE COLOR PIETRA. MANIGLIA H4 A ROSETTA QUADRA IN CROMO SATINATO.

Link model in horizontal oak stone color. H4 handle with matt chrome squared support.

Modelo Link todo en roble horizontal color piedra. Manija H4 con roseta cuadrada en satinado cromado.





LINK





MODELLO LINK LACCATO BIANCO LUCIDO RAL 9010, INSERTO CENTRALE IN ROVERE ORIZZONTALE COLOR PIETRA. MANIGLIA H4 A ROSETTA QUADRA IN CROMO SATINATO.

Link model RAL 9010 brilliant white, central insert in horizontal oak stone color. H4 handle with matt chrome squared support.

Modelo Link lacado brillante blanco RAL 9010, insercion central en roble horizontal color piedra. Manija H4 con roseta cuadrada en satinado cromado.

CACTUS



MODELLO CACTUS IN ROVERE ORIZZONTALE TINTO MIELE CON VETRO SATINATO BIANCO. MANIGLIA H4 A ROSETTA QUADRA IN CROMO SATINATO COMPLETA DI POMOLO PER DISPOSITIVO BLOCK COORDINATO.

Cactus model in horizontal honey oak with matt white glass. H4 handle with matt chrome squared support complete with coordinated block device.

Modelo Cactus en roble horizontal tenido miel con cristal satinado blanco. Manija H4 con roseta cuadrada en satinado cromado completo con perilla para el bloque.





CACTUS



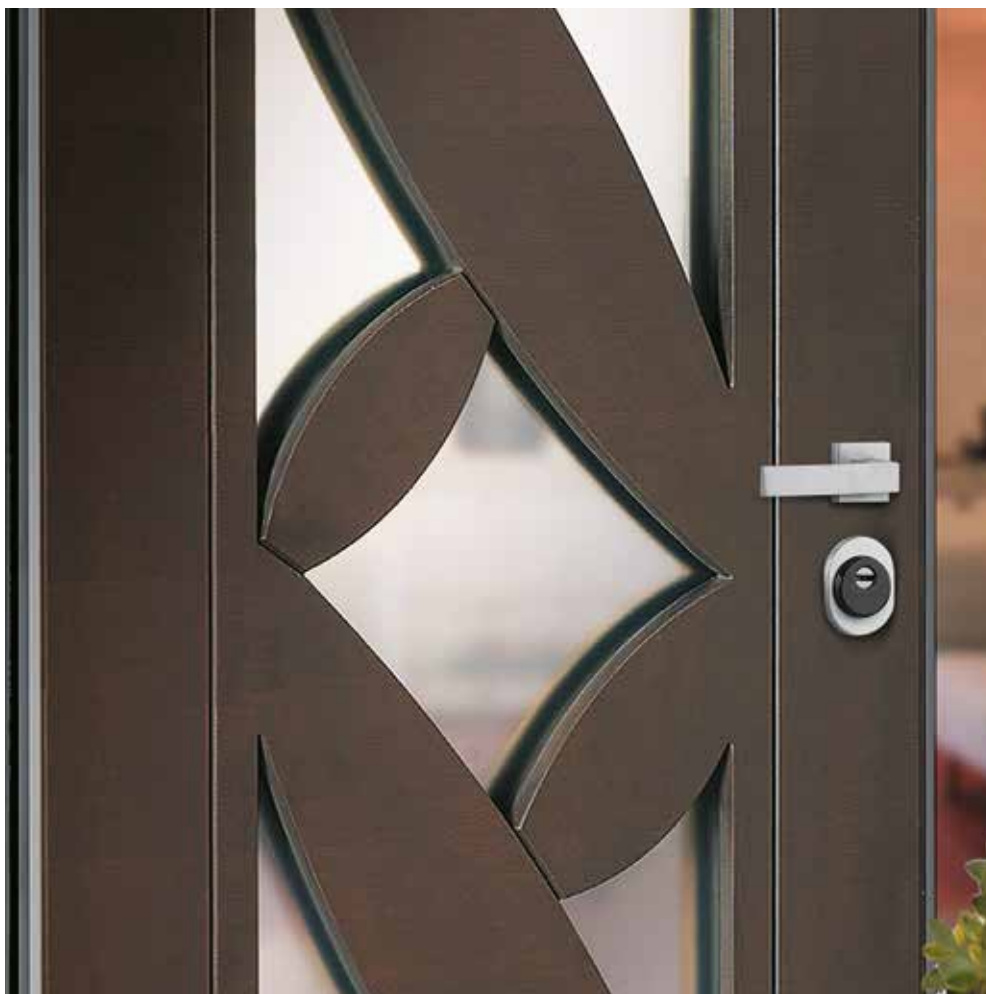

MODELLO CACTUS IN WENGÉ CON VETRO SATINATO BIANCO. MANIGLIA H4 A ROSETTA QUADRA IN CROMO SATINATO.

Cactus model in wengé with matt white glass. H4 handle with chrome squared support.

Modelo Cactus en wengé con cristal satinado blanco. Manija H4 con roseta cuadrada en satinado cromado.

MAP

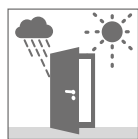

MODELLO MAP LACCATO BIANCO OPACO RAL 9010 CON VETRO SATINATO BIANCO. MANIGLIA H4 A ROSETTA QUADRA IN CROMO SATINATO.

Map model opaque RAL 9010 with matt white glass. H4 handle with matt chrome squared support.

Modelo Map lacado mate blanco RAL 9010 con cristal satinado blanco. Manija H4 con roseta cuadrada en satinado cromado.





MAP





MODELLO MAP IN ROVERE ORIZZONTALE COLOR PIETRA CON VETRO SATINATO BIANCO. MANIGLIONE FISSO 46 CM IN CROMO SATINATO.

Map model in horizontal oak stone color with matt white glass. Fixed handle 46 cm in matt chrome.

Modelo Map en roble horizontal color piedra con cristal satinado blanco. Barra fija 46 cm en cromo satinado.

NINE

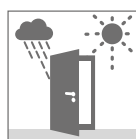

MODELLO IN ROVERE ORIZZONTALE COLOR PIETRA CON VETRO SATINATO BIANCO. MANIGLIA H4 A ROSETTA QUADRA IN CROMO SATINATO.

Nine model in horizontal oak stone color with matt white glass. H4 handle with matt chrome squared support.

Modelo Nine en roble horizontal color piedra con cristal satinado blanco. Manija H4 con roseta cuadrada en satinado cromado.









MODELLO NINE IN ROVERE ORIZZONTALE COLOR PIETRA CON VETRO SATINATO BIANCO. MANIGLIA H4 A ROSETTA QUADRA IN CROMO SATINATO.

Nine model in horizontal oak stone color with matt white glass. H4 handle with matt chrome squared support.

Modelo Nine en roble horizontal color piedra con cristal satinado blanco. Manija H4 con roseta cuadrada en satinado cromado.

VELA

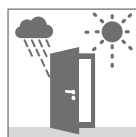

MODELLO VELA IN WENGÉ CON VETRO SATINATO BIANCO.
MANIGLIA H4 A ROSETTA QUADRA IN CROMO SATINATO.

Model VELA in wengé with matt white glass. H4 handle with
matt chrome squared support.

Modelo Vela en wengé con cristal satinado blanco. Manija H4
con roseta cuadrada en satinado cromado.

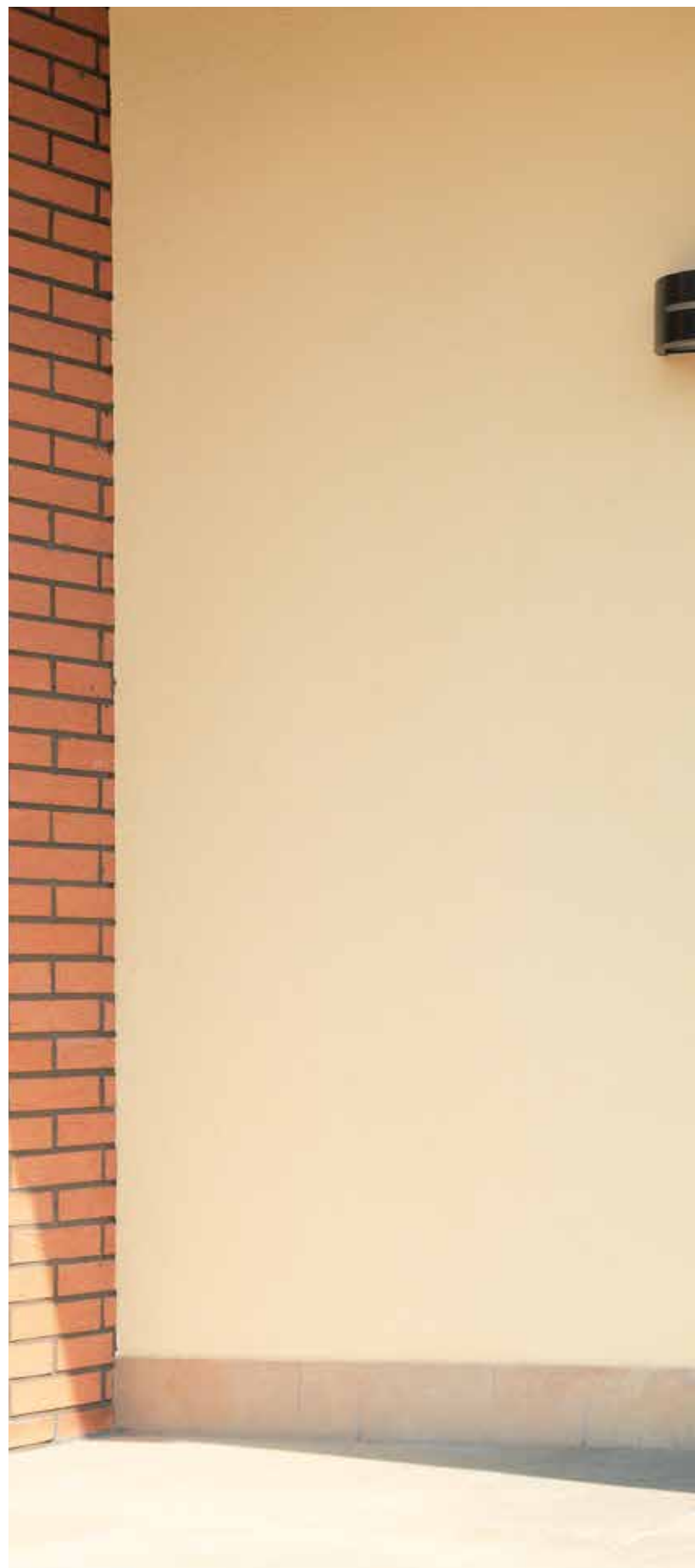







MODELLO VELA LACCATO BIANCO RAL 9010 CON VETRO SATINATO BIANCO.
MANIGLIA FENIX A ROSETTA QUADRA IN CROMO SATINATO.

Vela model RAL 9010 white with matt white glass. Fenix handle with matt chrome squared support.

Modelo Vela lacado blanco RAL 9010 con cristal satinado blanco. Manija Fenix con roseta cuadrada en satinado cromado.

OVAL

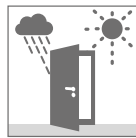

MODELLO OVAL IN ROVERE ORIZZONTALE COLOR PIETRA CON VETRO SATINATO BIANCO. MANIGLIA FENIX A ROSETTA QUADRA IN CROMO SATINATO.

Oval model in horizontal oak stone color with matt white glass. Fenix handle with matt chrome squared support.

Modelo Oval en roble horizontal color piedra con cristal satinado blanco. Manija Fenix con roseta cuadrada en satinado cromado.



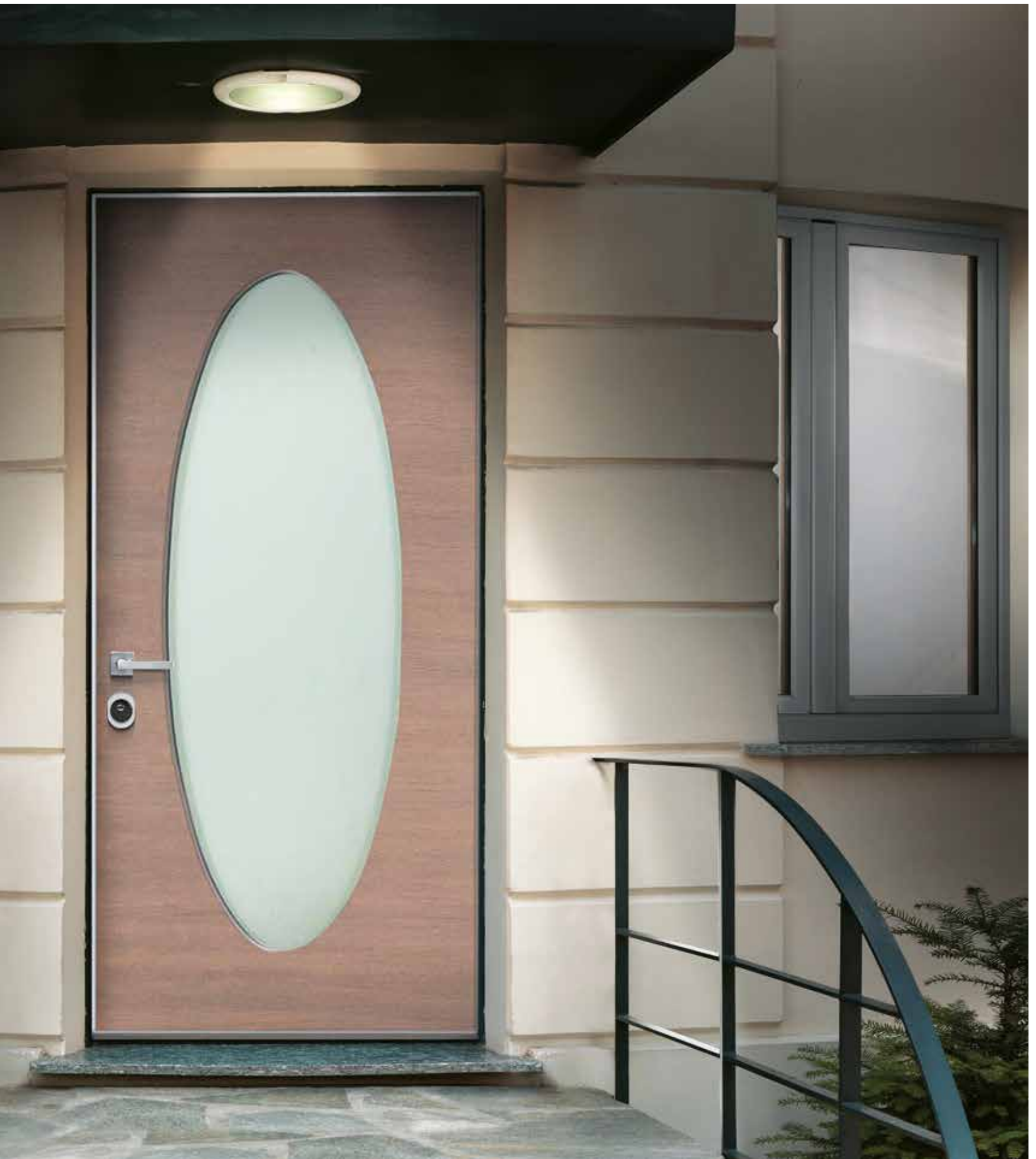

OVAL





MODELLO OVAL LACCATO BIANCO RAL 9010 CON VETRO SATINATO BIANCO. MANIGLIA H4 A ROSETTA QUADRA IN CROMO SATINATO COMPLETA DI POMOLO PER DISPOSITIVO BLOCK COORDINATO.

Oval model RAL 9010 with matt white glass. H4 handle with matt chrome squared support complete with coordinated block device.

Modelo Oval lacado blanco RAL 9010 con cristal satinado blanco. Manija H4 con roseta cuadrada en satinado cromado completo con perilla para el bloque.

TEN



MODELLO TEN IN ROVERE ORIZZONTALE COLOR PIETRA CON VETRO SATINATO BIANCO. MANIGLIA H4 A ROSETTA QUADRA IN CROMO SATINATO.

Ten model in horizontal oak stone color with matt white glass. H4 handle with matt chrome squared support.

Modelo Ten en roble horizontal color piedra con cristal satinado blanco. Manija H4 con roseta cuadrada en satinado cromado.







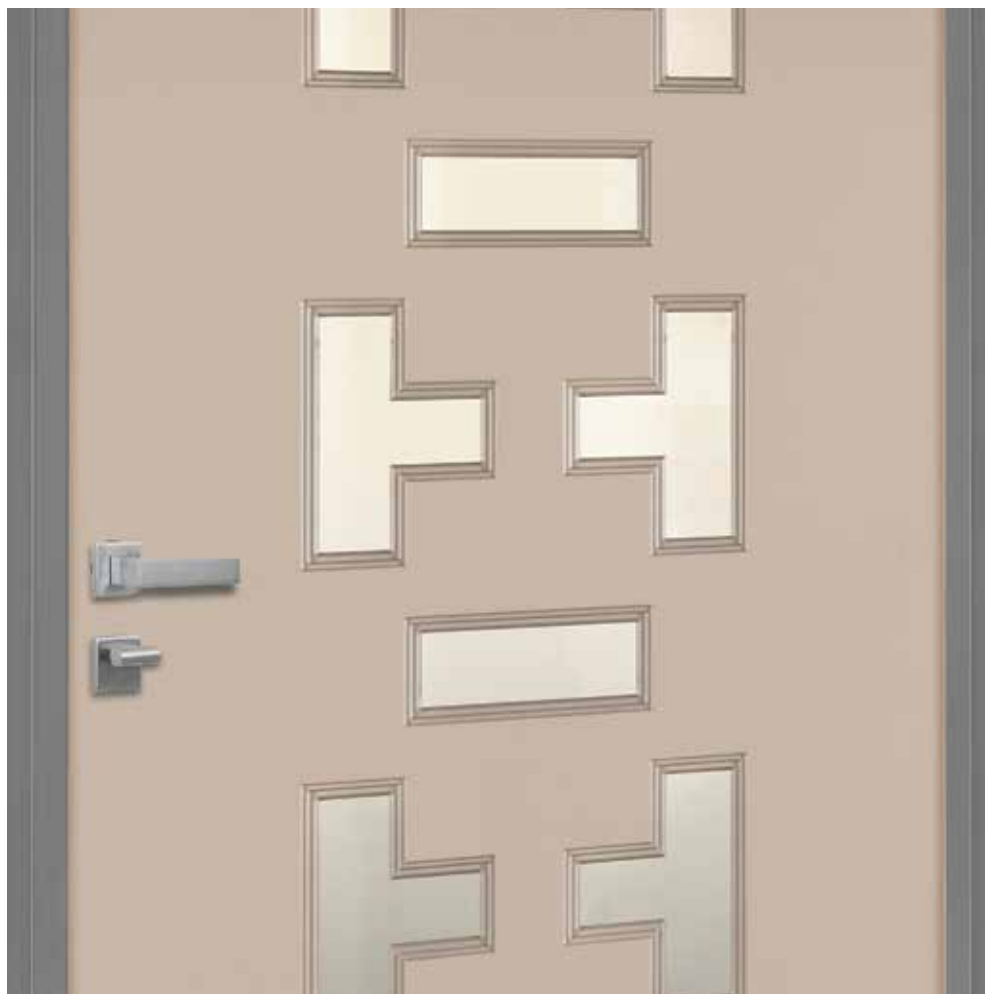

MODELLO TEN LACCATO RAL 1019 CON VETRO SATINATO BIANCO. MANIGLIA H4 A ROSETTA QUADRA IN CROMO SATINATO.

Ten model lacquered RAL 1019 with matt white glass. H4 handle with matt chrome squared support.

Modelo Ten lacado RAL 1019 con cristal satinado blanco. Manija H4 con roseta cuadrada en satinado cromado.

PAIS A111

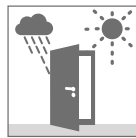

MODELLO PAIS A111 IN TEAK CON FRESATURA ORIZZONTALE.
MANIGLIA H4 A ROSETTA QUADRA IN CROMO SATINATO.

Pais model A111 in teak with horizontal engraving. H4 handle with matt chrome squared support.

Modelo País A111 en teca con fresado horizontal. Manija H4 con roseta cuadrada en satinado cromado.



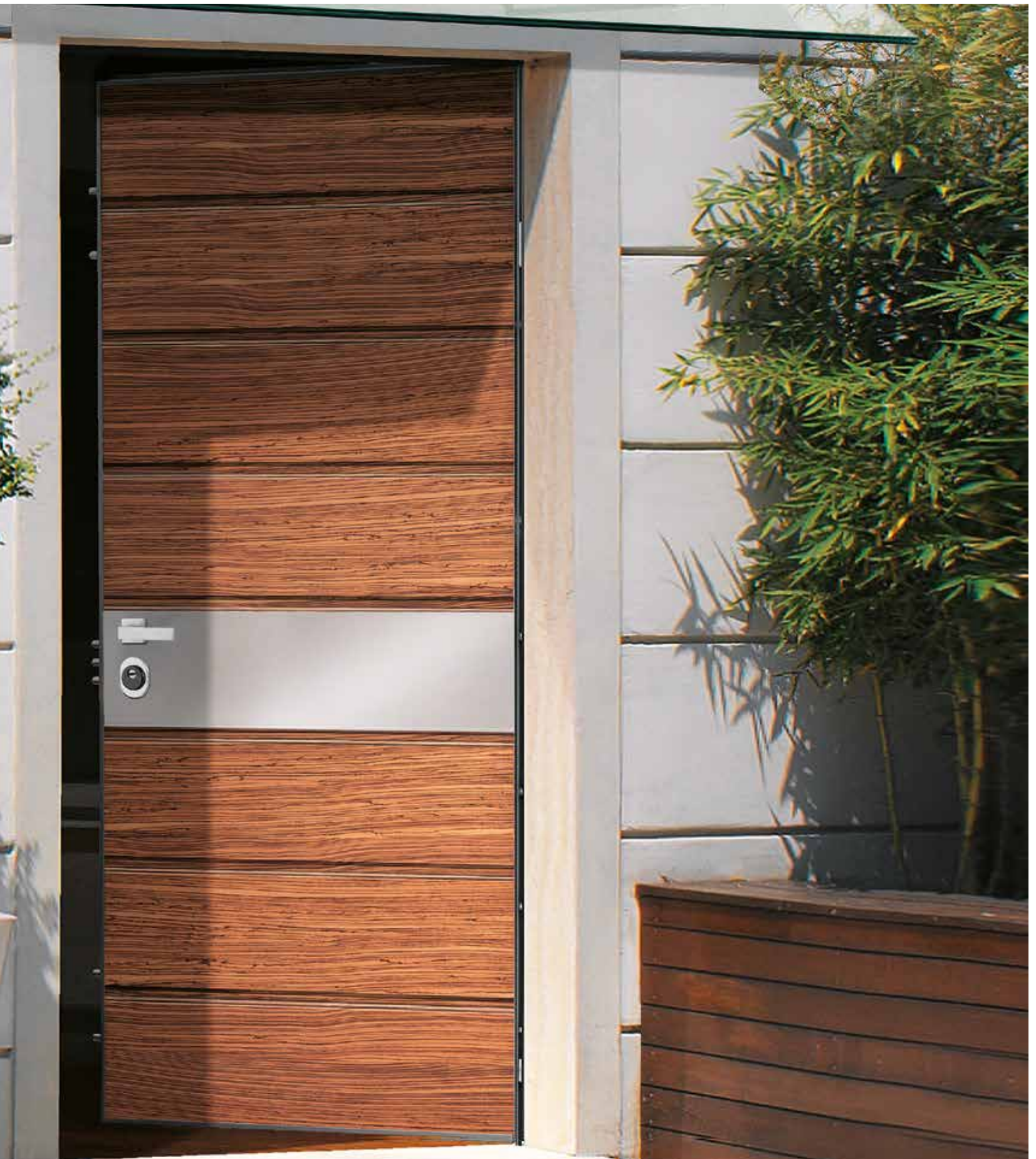

PAIS LIGHT





MODELLO PAIS NELLA VERSIONE LIGHT DA 6MM DI SPESSORE IN LAMINATO LARICE MATRIX CON FASCIA IN ACCIAIO INOX. MANIGLIA H4 A ROSETTA QUADRA IN CROMO SATINATO.

Pais light model with 6 mm thick laminated Matrix larch panel with sheet strip. H4 handle with matt chrome squared support.

Modelo País en la versión light de 6 mm de espesor, Matrix alerce laminado con banda de acero inoxidable. Manija H4 con roseta cuadrada en satinado cromado.





MODELLO PAIS REALIZZATO CON MATTONCINI DI GRES PORCELLANATO E FASCIA INOX. MANIGLIA H4 A ROSETTA QUADRA IN CROMO SATINATO.

Pais model composed by porcelain stoneware and sheet strip. H4 handle with matt chrome squared support.

Modelo Pais con ladrillos de porcelana y banda de acero inoxidable. Manija H4 con roseta cuadrada en satinado cromado.

PAIS LIGHT





MODELLO PAIS NELLA VERSIONE LIGHT DA 6 MM DI SPESSORE IN LAMINATO PALISSANDRO MATRIX CON FASCIA IN ACCIAIO INOX. MANIGLIA FENIX A ROSETTA QUADRA IN CROMO SATINATO.

Pais light model with 6 mm thick laminated Matrix rose oak panel with sheet strip. Fenix handle with matt chrome squared support.

Modelo País en la versión light de 6 mm de espesor, laminado Matrix palisandro con banda de acero inoxidable. Manija Fenix con roseta cuadrada en satinado cromado.

CARGO



MODELLO CARGO CON FRESATURE PANTOGRAFATE. NELLA FOTO È PRESENTATO IN MDF LACCATO ROSSO RAL 3013. MANIGLIA H4 A ROSETTA QUADRA IN CROMO SATINATO.

Cargo model with engraved pantographing. It is shown in the photo in RAL 3013 red MDF. H4 handle with matt chrome squared support.

Modelo Cargo con ranuras enrutadas. En la imagen se presenta en rojo RAL 3013 MDF lacado. Manija H4 con roseta cuadrada en satinado cromado.





CARGO





MODELLO CARGO INOX CON FRESATURE PANTOGRAFATE. NELLA FOTO È PRESENTATO IN MDF LACCATO GRIGIO RAL 7024. ESTERNAMENTE MONTA UN POMOLO FISSO IN CROMO SATINATO.

Cargo model Inox with engraved pantographing. It is shown in the photo in MDF lacquered RAL 7024 grey. Externally, it is set a fixed matt chrome knob.

Modelo Cargo de acero con ranuras enrutadas. En la imagen se presenta en gris MDF lacado RAL 7024. Externamente equipado con un pomo fijo en cromo satinado.

LISTEN

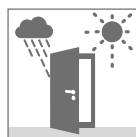

MODELLO LISTEN IN LACCATO GRIGIO CON MANIGLIONE FISSO ESTERNO 116 CM IN ALLUMINIO ARGENTO.

Listen model gray lacquered with external fixed handle 116 cm in silver aluminum.

Modelo Listen lacado en gris con barra fija externa 116 cm en aluminio plata.





LISTEN





MODELLO LISTEN IN WENGÉ. MANIGLIA H4 A ROSETTA QUADRA IN CROMO SATINATO.

Listen Model in wengé oak. H4 handle with matt chrome squared support.

Modelo Listen en roble horizontal wengé. Manija H4 con roseta cuadrada en satinado cromado.

INOUT



MODELLO INOUT 1 LACCATO BIANCO RAL 9010. IL RIVESTIMENTO È CARATTERIZZATO DAL BASSORILIEVO CENTRALE PANTOGRAFATO. MANIGLIA H4 A ROSETTA QUADRA IN CROMO SATINATO.

InOut 1 model white RAL 9010. The panel is featured by a central pantographed bas-relief. H4 handle with matt chrome squared support.

Modelo InOut 1 lacado blanco RAL 9010. El revestimiento se caracteriza por bajo relieve acanalado central. Manija H4 con roseta cuadrada en satinado cromado.









MODELLO INOUT 2 LACCATO GRIGIO RAL 7036. IL RIVESTIMENTO È CARATTERIZZATO DAL BASSORILIEVO CENTRALE PANTOGRAFATO. MANIGLIA H4 A ROSETTA QUADRA IN CROMO SATINATO.

Model InOut 2 lacquered grey RAL 7036. The panel is featured by a central pantographed bas-relief. H4 handle with matt chrome squared support.

Modelo InOut 2 lacado gris RAL 7036. El revestimiento se caracteriza por bajo relieve acanalado central. Manija H4 con roseta cuadrada en satinado cromado.

SQUARE

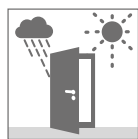

MODELLO SQUARE IN ROVERE ORIZZONTALE COLOR TABACCO. MANIGLIA H4 A ROSETTA QUADRA IN CROMO SATINATO COMPLETA DI POMOLO PER DISPOSITIVO BLOCK COORDINATO.

Square model in horizontal oak tobacco color. H4 handle with matt chrome squared support complete with coordinated block device.

Modelo Square en color roble color tabaco horizontal. Manija H4 con roseta cuadrada en satinado cromado completo con perilla para el bloque.



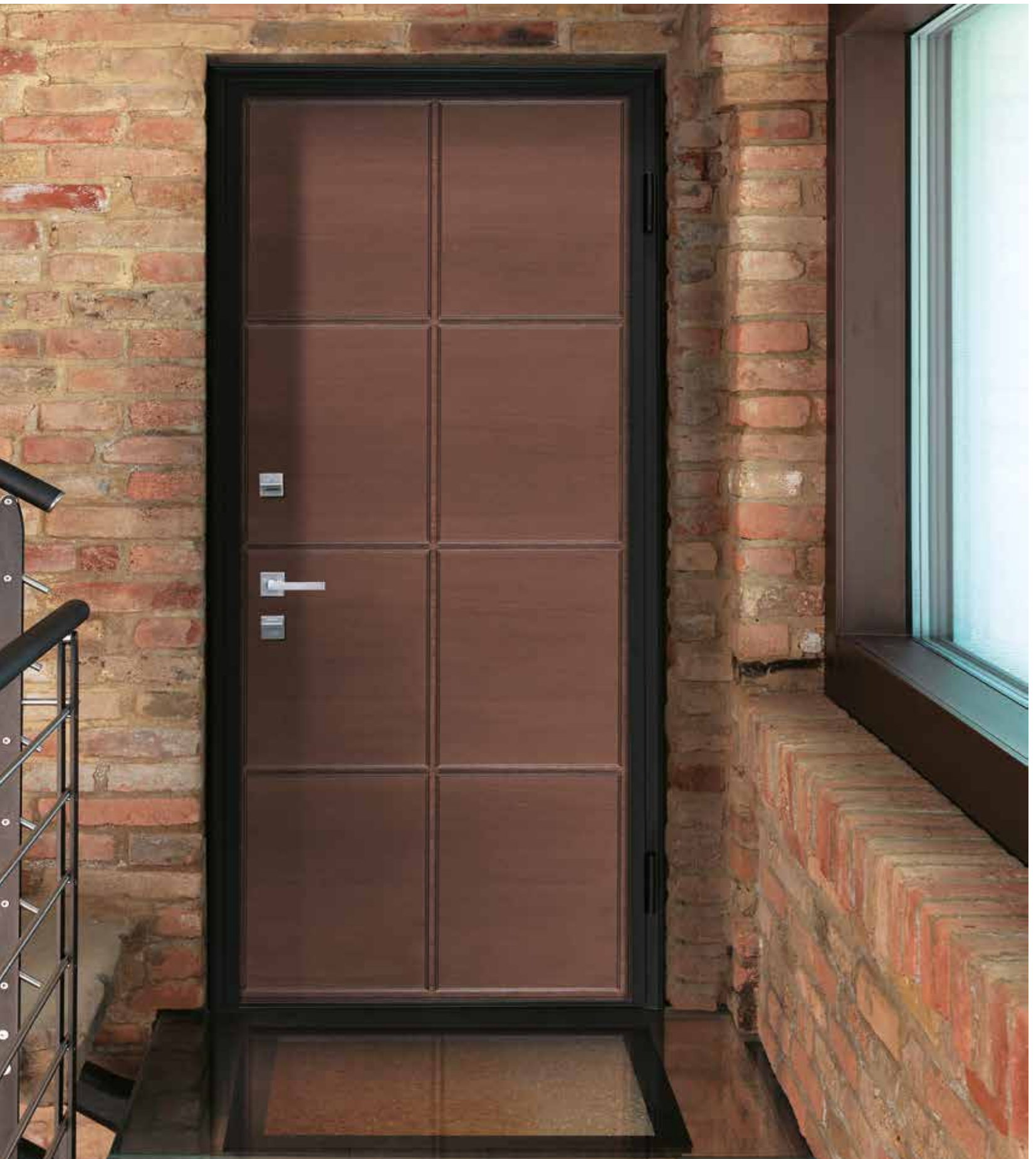

SQUARE





MODELLO SQUARE LACCATO RAL 1019. MANIGLIA H4 A ROSETTA QUADRA IN CROMO SATINATO.

Square model lacquered RAL 1019. H4 handle with matt chrome squared support.

Modelo Square lacado RAL 1019. Manija H4 con roseta cuadrada en satinado cromado.

LINEA



MODELLO LINEA IN ROVERE ORIZZONTALE COLOR TABACCO CON INSERTO IN ACCIAIO INOX. MANIGLIA H4 A ROSETTA QUADRA IN CROMO SATINATO.

Linea Model in horizontal oak tobacco color with a sheet insert. H4 handle with matt chrome squared support.

Modelo Linea en roble color tabaco horizontal con inserto de acero inoxidable. Manija H4 con roseta cuadrada en satinado cromado.





LINEA

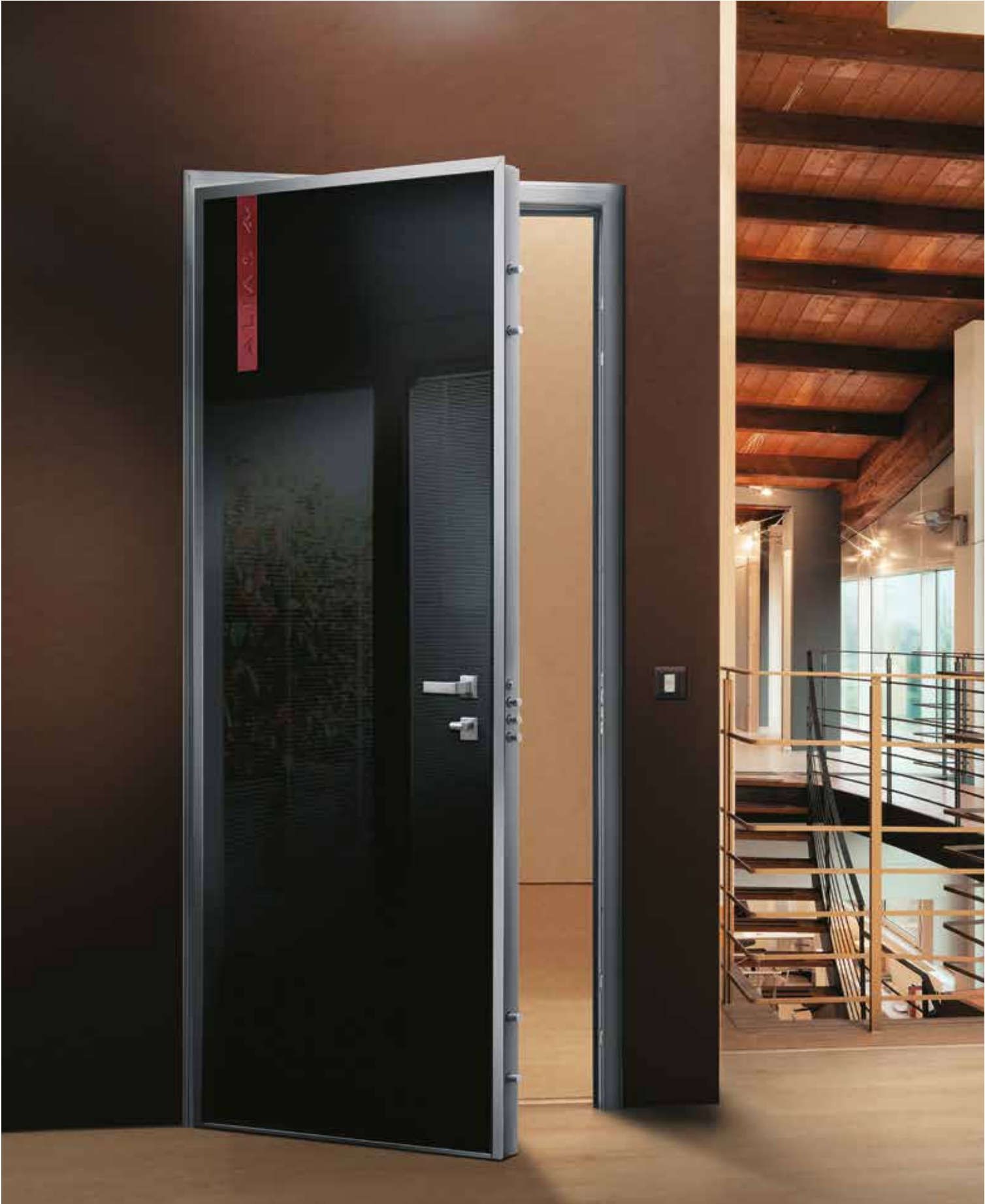



MODELLO LINEA IN MDF LACCATO NERO LUCIDO CON INSERTO LACCATO ROSSO LUCIDO. MANIGLIA H4 A ROSETTA QUADRA IN CROMO SATINATO.

Linea model in MDF brilliant black with brilliant red insert. H4 handle with matt chrome squared support.

Modelo Linea en MDF negro lacado brillante con inserto en lacado rojo brillante. Manija H4 con roseta cuadrada en satinado cromado.

AFORISMI



MODELLO AFORISMI CON FONDO BIANCO. MANIGLIA H4 A ROSETTA QUADRA IN CROMO SATINATO.

Aforismi model with white base. H4 handle with matt chrome squared support.

Modelo Aforismi con fondo blanco. Manija H4 con roseta cuadrada en satinado cromado.



Le monde
ous les instants
est merveille
illeux...

est merveille
tous les
eux... tous
instants

oude est
sont merve
erveilleux...





MODELLO AFORISMI CON FONDO NERO. MANIGLIA H4 A ROSETTA QUADRA IN CROMO SATINATO.

Aforismi model with black base. H4 handle with matt chrome squared support.

Modelo Aforismi con el fondo negro. Manija H4 con roseta cuadrada en satinado cromado.

MOTION

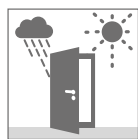

MODELLO MOTION IN WENGÉ CON POMOLO FISSO ESTERNO
IN CROMO SATINATO.

Motion model in wengé. Externally it is set a fixed matt chrome knob.

Modelo Motion en wengé externamente equipado con un pomo fijo em cromo satinado.





MOTION





MODELLO MOTION LACCATO BIANCO RAL 9010 CON POMOLO FISSO IN CROMO SATINATO.

Motion model in white laquered RAL 9010.
Fixed handle with matt chrome knob.

Modelo Motion lacado blanco RAL 9010
con un pomo fijo en cromo satinado.

TRADITION.

ELEMENTI INCONFONDIBILI E INTRAMONTABILI, PERFEZIONATI DALLA NATURA E DA UNA CONTINUA RICERCA. L'ESSENZA E IL COLORE DEL LEGNO, AUTENTICO RAPPRESENTANTE DI STILE PER UN RAFFINATO EQUILIBRIO TRA IERI E OGGI. LA LINEA TRADITION, CALDA ED ESSENZIALE IN OGNI SUO DETTAGLIO.

Unique, evergreen elements that nature and everlasting research have shaped. The essence and the wood color are style symbols of a sophisticated match between the present and the past. Tradition line, essential and warm in each detail.

Elementos inconfundibles e imperecederos, perfeccionados por la naturaleza y por un continuo estudio. La esencia y el color de la madera, auténtico emblema de estilo en un distinguido equilibrio entre el pasado y el presente. La línea Tradition, cálida y esencial en cada detalle.



BASIC PANNELLI IMPIALLACCIATI

Spessore 6 mm

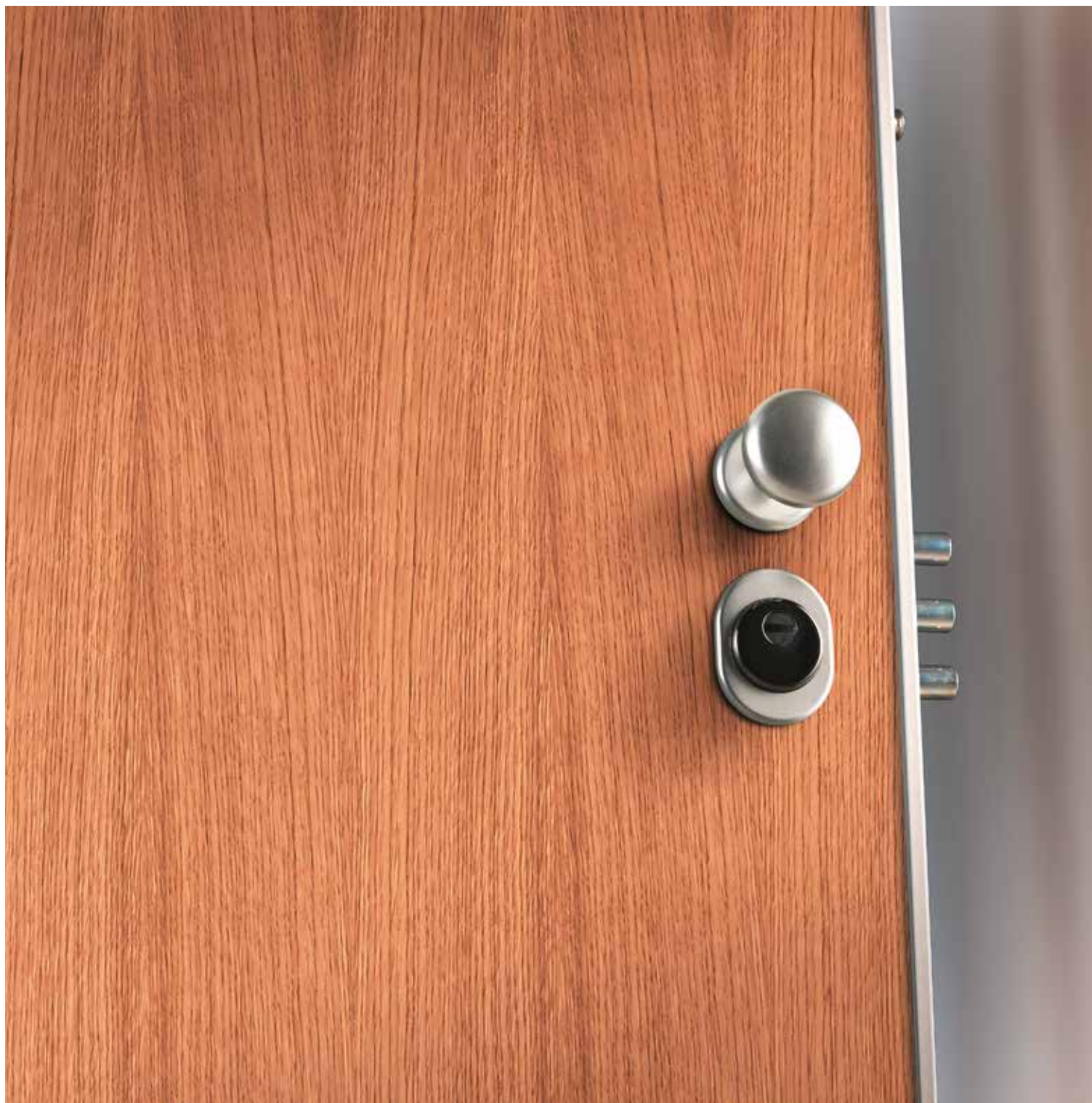

* L'INSTALLAZIONE È CONSENTITA SOLO ALL'OMBRA IN ATRII E PIANEROTTOLI.
Installation allowed in shade, atriums and half spaces. / La instalación está permitida sólo en lugares sombreados, atrios y descansillos.

Flat chipboard panels

6 mm thickness

Tableros de fibra de madera

Espesor 6 mm



TANGANICA CHIARO

Light tanganyika / Nogal tanganika claro



MOGANO CHIARO

Light mahogany / Caoba claro



ROVERE GRIGIO ORIZZONTALE P

Grey horizontal oak / Roble gris horizontal



TANGANICA MEDIO

Medium tanganyika / Nogal tanganika medio



MOGANO MEDIO

Medium mahogany / Caoba medio



ROVERE ORIZZONTALE SBIANCATO P

Bleached horizontal oak / Roble blanqueado horizontal



TANGANICA SCURO

Dark tanganyika / Nogal tanganika scuro



MOGANO SCURO

Dark mahogany / Caoba oscuro

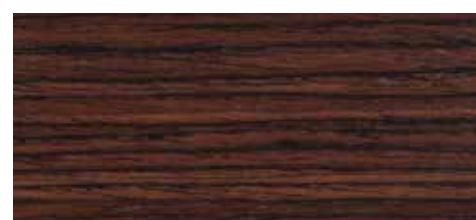

ROVERE WENGÉ ORIZZONTALE P

Wengé horizontal oak / Roble wengé horizontal



CILIEGIO MEDIO

Cherry / Cerezo medio



CASTAGNO

Chestnut / Castaño



ROVERE MIELATO ORIZZONTALE P

Honey horizontal oak / Roble miel horizontal



TANGANICA CILIEGIATO

Cherry tanganyika / Nogal tanganika color cerezo



NOCE NAZIONALE

Italian walnut / Nogal nacional



ROVERE MIELATO VERTICALE

Honey vertical oak / Roble miel vertical

BASIC PANNELLI LAMINATINI

Spessore 6 mm

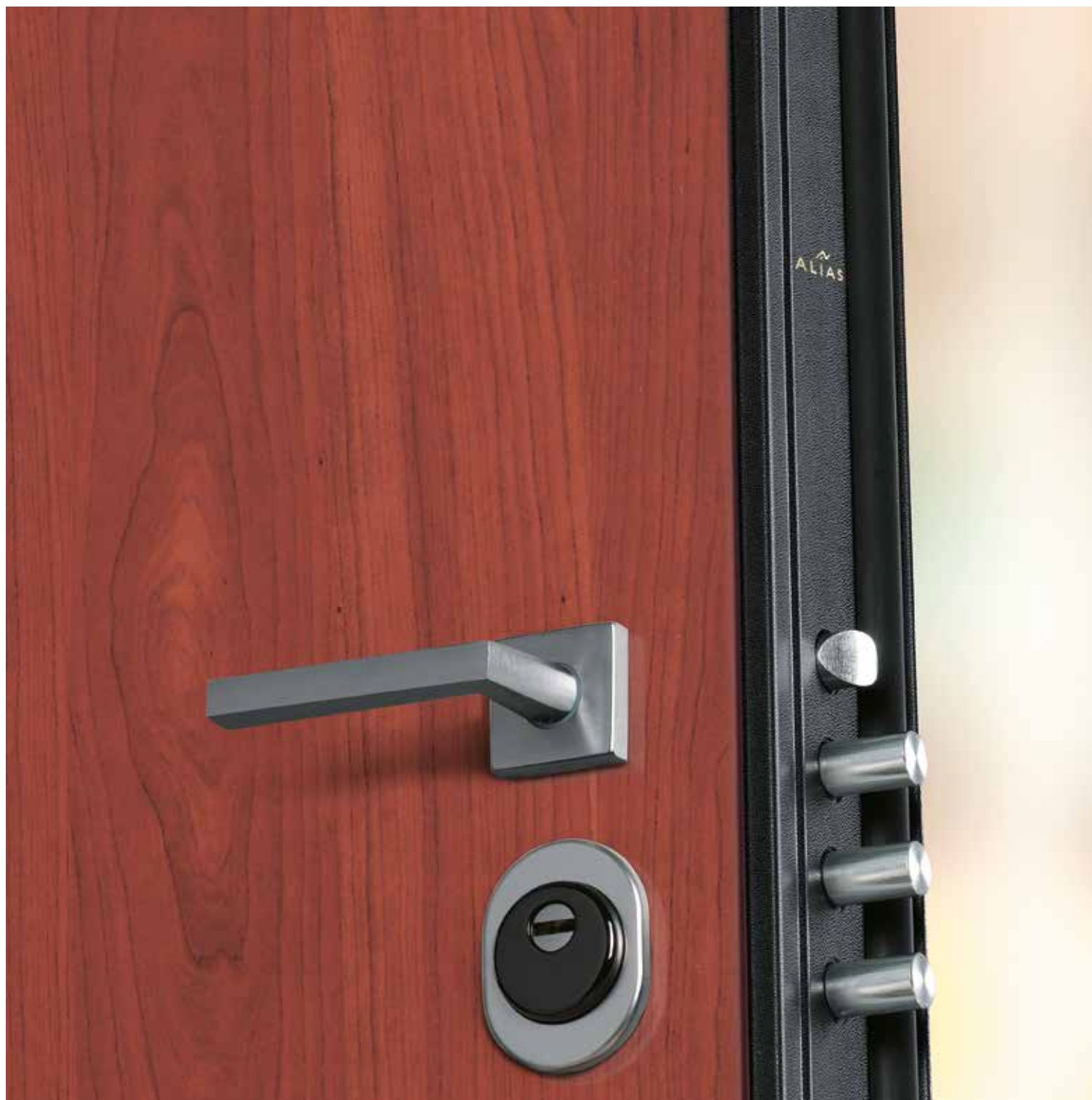

* L'INSTALLAZIONE È CONSENTITA SOLO ALL'OMBRA IN ATRII E PIANEROTTOLI.

Installation allowed in shade, atriums and half spaces. / La instalación está permitida sólo en lugares sombreados, atrios y descansillos.

Laminated wood panels

6 mm thickness

Tableros laminados

Espesor 6 mm

DISPONIBILE
ANCHE IN
VERTICALE



ROVERE WENGÉ L ORIZZONTALE
Wengé oak / Roble wengé



ROVERE SBIANCATO L ORIZZONTALE
Bleached oak / Roble blanqueado

DISPONIBILE
ANCHE IN
VERTICALE



TANGANICA CHIARO L
Light tanganyika / Nogal tanganika claro



TANGANICA SCURO L
Dark tanganyika / Nogal tanganika oscuro



NOCE BIONDO C
Blonde Walnut / Nogal Rubio



NOCE NAZIONALE C
Italian walnut / Nogal nacional



FAGGIO L
Beech / Haya



CILIEGIO C
Cherry / Cerezo



ROVERE L
Oak / Roble

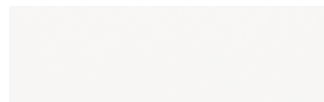

RAL 9016 L

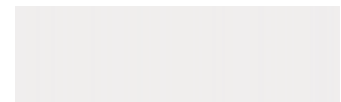

BIANCO CARENA



RAL 9010 L

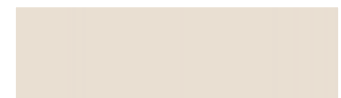

RAL 1013

BASIC PANNELLI LAMINATINI MATRIX

Spessore 6 mm



* L'INSTALLAZIONE È CONSENTITA SOLO ALL'OMBRA IN ATRII E PIANEROTTOLI.

Installation allowed in shade, atriums and half spaces. / La instalación está permitida sólo en lugares sombreados, atrios y descansillos.

Matrix laminated wood panels

6 mm thickness



MATRIX BIANCO

Matrix white / Blanco Matrix

Matrix tableros laminados

Espesor 6 mm



MATRIX MARBELLA

Matrix marbella / Marbella Matrix



MATRIX ROVERE GRIGIO

Matrix grey oak / Roble gris Matrix



MATRIX LARICE

Matrix larch / Alerce Matrix



MATRIX PALISSANDRO

Matrix rose oak / Palisandro Matrix

BASIC PANNELLI LAMINATI TRANCHÉ

Spessore 6 mm

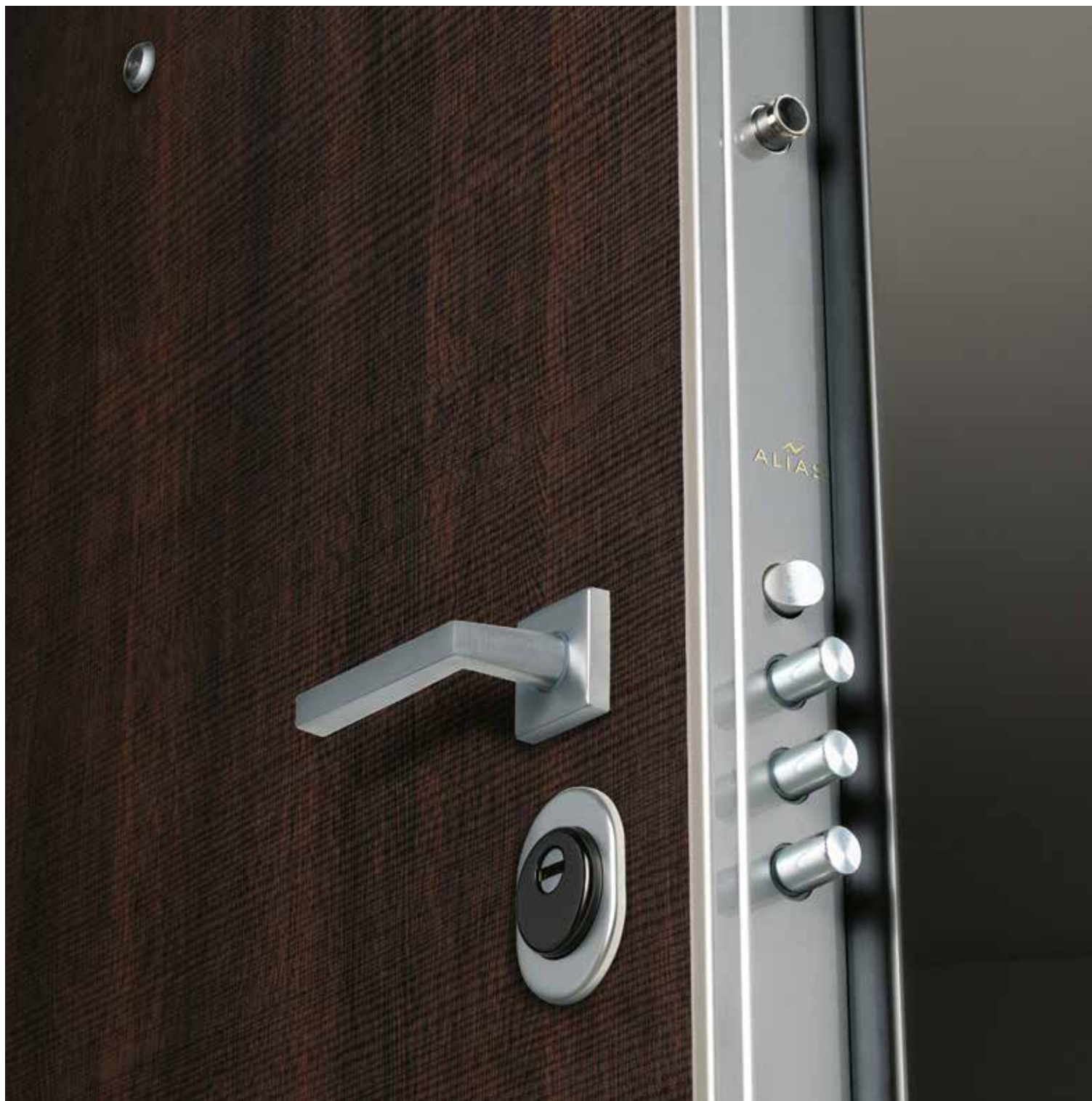

* L'INSTALLAZIONE È CONSENTITA SOLO ALL'OMBRA IN ATRII E PIANEROTTOLI.
Installation allowed in shade, atriums and half spaces. / La instalación está permitida sólo en lugares sombreados, atrios y descansillos.

Tranché laminated
wood panels
6 mm thickness

Tableros laminados
tranché
Espesor 6 mm



CENERE
Ash / Ceniza



CAFFÈ
Cafè / Cafè



TERRA
Earth / Tierra



SABBIA
Sand / Arena

BASIC ARDESIA

Facestone



* L'INSTALLAZIONE È CONSENTITA SOLO ALL'OMBRA IN ATRIUMI E PIANEROTTOLI.
Installation allowed in shade, atriums and half spaces. / La instalación está permitida sólo en lugares sombreados, atrios y descansillos.

BASIC VULCANO

Facestone



BASIC PANNELLI LACCATI LUCIDO/OPACHI

Spessore 6 mm



* L'INSTALLAZIONE È CONSENTITA SOLO ALL'OMBRA IN ATRII E PIANEROTTOLI.
Installation allowed in shade, atriums and half spaces. / La instalación está permitida sólo en lugares sombreados, atrios y descansillos.

Laquered MDF panels
available with opaque or brilliant finishing.
6 mm thickness

Tableros laqueados
disponibles con acabado mate o con brillo.
Espesor 6 mm



BASIC LINE



* L'INSTALLAZIONE È CONSENTITA SOLO ALL'OMBRA IN ATRII E PIANEROTTOLI.
Installation allowed in shade, atriums and half spaces. / La instalación está permitida sólo en lugares sombreados, atrios y descansillos.

ALTRE CONFIGURAZIONI DISPONIBILI SU RICHIESTA.

Others configurations available upon request.

Otras configuraciones disponibles a petición.



**INSERTO 1
SU PANNELLO LAMINATO
TRANCHÉ CENERE**

Insert 1 on ash tranché
laminated wood panel

Insercio 1 su tablero
laminado tranché ceniza



**INSERTO 10
SU PANNELLO MATRIX
ROVERE GRIGIO**

Insert 10 on matrix grey
oak laminated wood panel

Insercio 10 su tablero
laminado roble gris matrix

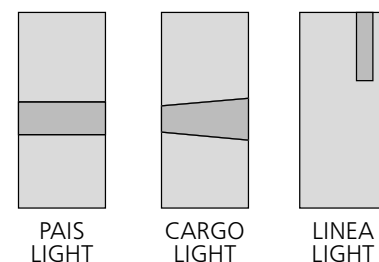
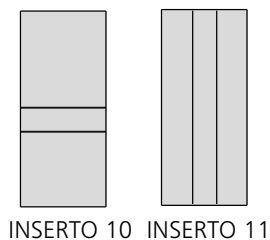
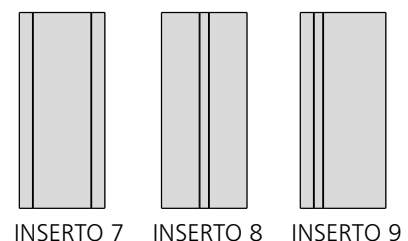
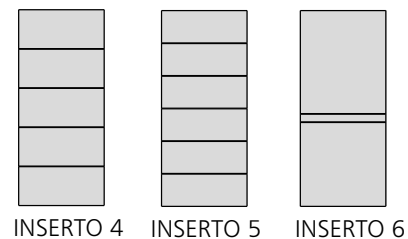
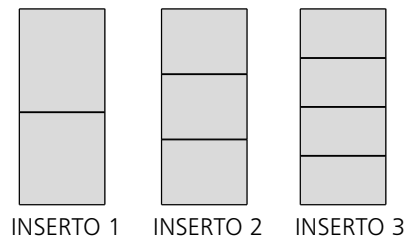

**INSERTO 4
SU PANNELLO
IN MDF
RAL 9010**

Insert 4 on laquered
mdf panel RAL 9010

Insercio 4 su tablero
laqueado RAL 9010



**INSERTO 8
SU PANNELLO
IN METACRILATO
ROSSO LUCIDO**

Insert 8 on
methacrylate
laquered red panel

Insercio 8 su tablero
metacrilato rojo

INTARSIO PANNELLI IMPIALLACCIATI

Spessore 6 mm

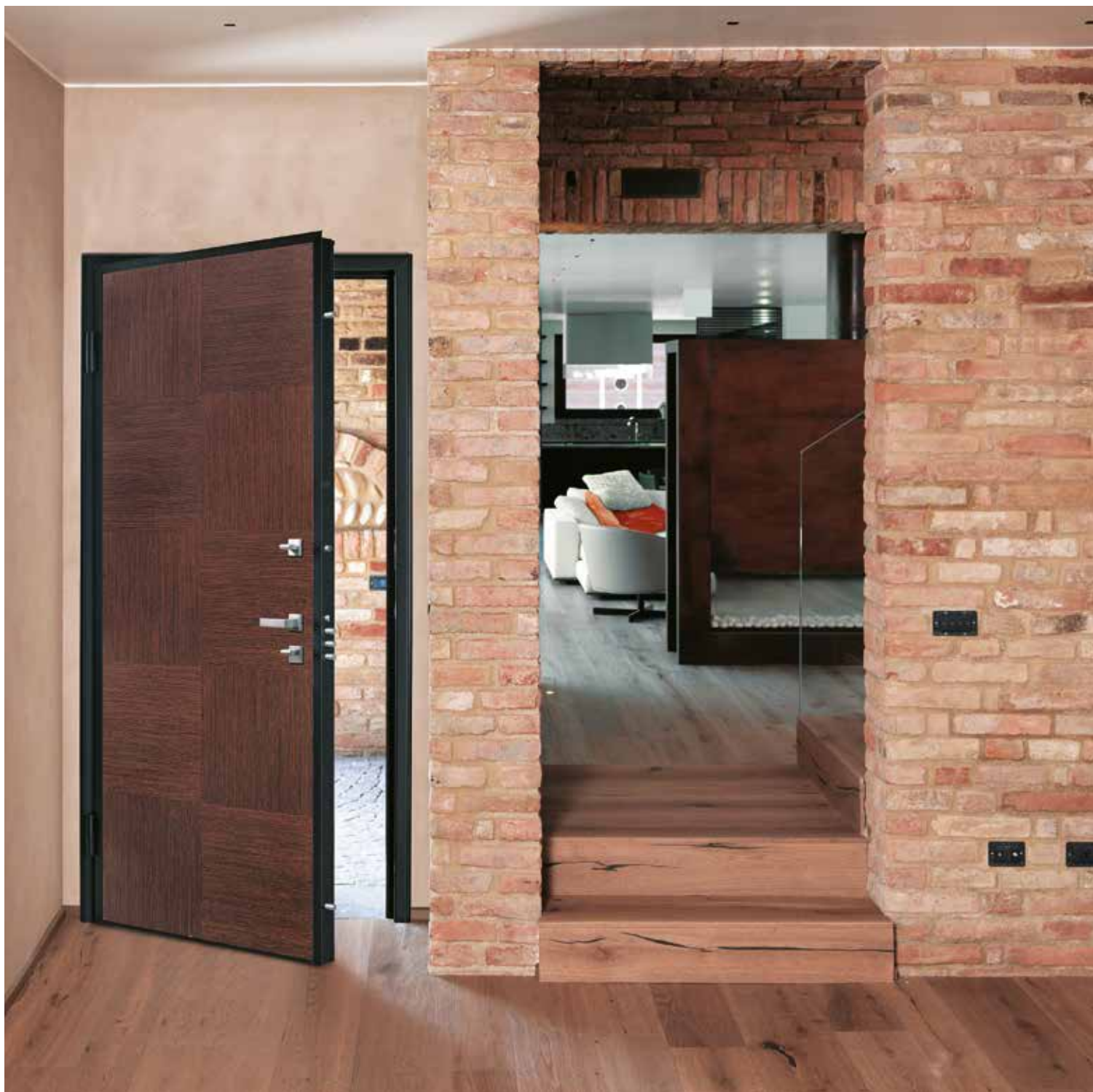

* L'INSTALLAZIONE È CONSENTITA SOLO ALL'OMBRA IN ATRII E PIANEROTTOLI.

Installation allowed in shade, atriums and half spaces. / La instalación está permitida sólo en lugares sombreados, atrios y descansillos.

Flat chipboard panels

6 mm thickness

Tableros de madera

Espesor 6 mm



**MOD. A51
NOCE
NAZIONALE**
Italian Walnut
Nogal Nacional



**MOD. A51
TANGANICA
CHIARO**
Light Tanganyika
Nogal tanganika
claro



**MOD. A51
TANGANICA
TINTO**
Medium Tanganyika
Nogal tanganika
medio



**MOD. A52
NOCE
NAZIONALE**
Italian Walnut
Nogal Nacional



**MOD. A52
TANGANICA
TINTO**
Medium Tanganyika
Nogal tanganika
medio



**MOD. A52
TANGANICA
CHIARO**
Light Tanganyika
Nogal tanganika
claro



**MOD. A53
TANGANICA
NATURALE**
Natural Tanganyika
Nogal tanganika
claro



**MOD. A54
ROVERE WENGÉ**
Wengé Oak
Roble wengé



**MOD. A54
ROVERE
SBIANCATO**
Bleached Oak
Roble blanqueado



**MOD. A55
ROVERE WENGÉ**
Wengé Oak
Roble wengé

NATUR - ALL PANNELLI IN ALLUMINIO

Spessore 6 mm



* SI CONSIGLIA L'INSTALLAZIONE DEL RIVESTIMENTO IN POSIZIONE RIPARATA SOTTO LE TETTOIE, PORTICATI E COPERTURE DI ALMENO CM 100.
Paneling installation is suggested in sheltered position under roofs, porches and ceiling of at least cm. 100. / Se aconseja la instalación de los
tableros en lugares amparados debajo de marquesinas, portales y techados de al menos cm 100.

Aluminium panels

6 mm thickness

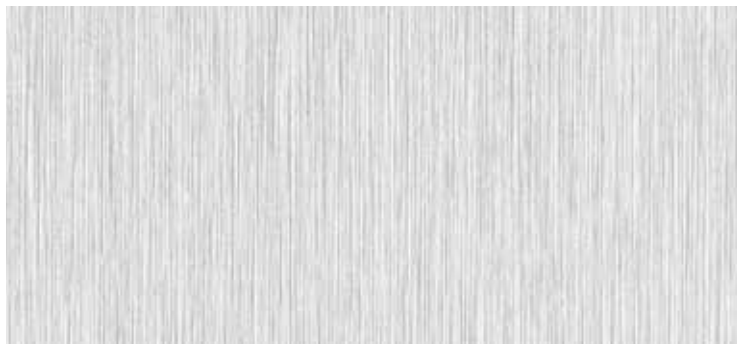

Tableros de aluminio

Espesor 6 mm

ALLUMINIO LISCIO

Flat Aluminium
Aluminio liso



ALLUMINIO RIGATO ORIZZONTALE

Horizontal striped Aluminium
Aluminio con rayas horizontales



ALLUMINIO RIGATO VERTICALE

Vertical striped Aluminium
Aluminio con rayas verticales

SKIPPER PANNELLI IN MULTISTRATO

compensato marino o MDF idrofugo.

Spessore 15 mm

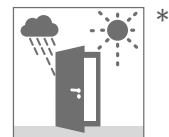

* L'INSTALLAZIONE È CONSENTITA ANCHE ALLA PRESENZA DI SOLE, PIOGGIA E GELO.

Installation is allowed also in the sun, under rain and frost. / La instalación está permitida también bajo el sol, la lluvia y el hielo.

Engraved marine
plywood or waterproof MDF panels.
15 mm thickness

Tableros de madera cruzada
fresados o en MDF impermeable.
Espesor 15 mm



MOD. A281



MOD. A282



MOD. A109



MOD. A285

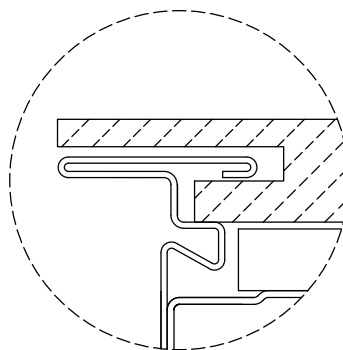
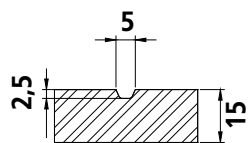

OPTIONAL: PANNELLO INTERNO
AVVOLGENTE A COPERTURA
DELLA CARENATURA

Optional: internal panel that envelops
and covers leaf profile

Opcional: tablero interno que cubre
el marco



LISCIO

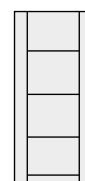

A281



A285



AL01

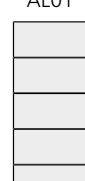

AL04

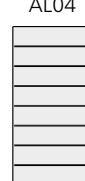

AL08



AL09

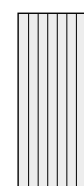

A72

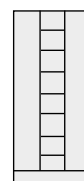

A282

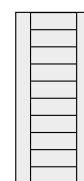

A109

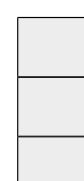

AL02

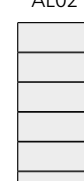

AL05

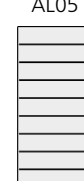

AL09



A74



A284

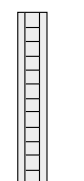

A110

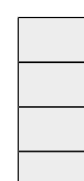

AL03

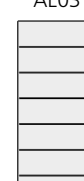

AL06

SKIPPER - DIAMANTE GLASS PANNELLI IN MULTISTRATO

compensato marino o MDF idrofugo.

Spessore 15 mm

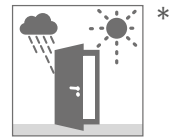

* L'INSTALLAZIONE È CONSENTITA ANCHE ALLA PRESENZA DI SOLE, PIOGGIA E GELO.

Installation is allowed also in the sun, under rain and frost. / La instalación está permitida también bajo el sol, la lluvia y el hielo.

Engraved marine

plywood or dampness proof MDF panels.
15 mm thickness

Tableros de madera cruzada

fresados o en MDF a prueba de humedad.
Espesor 15 mm

Diamante glass

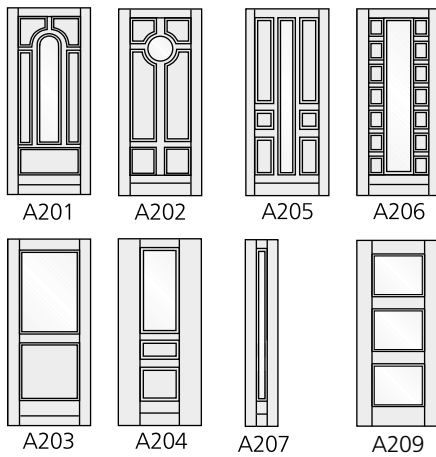

Skipper glass

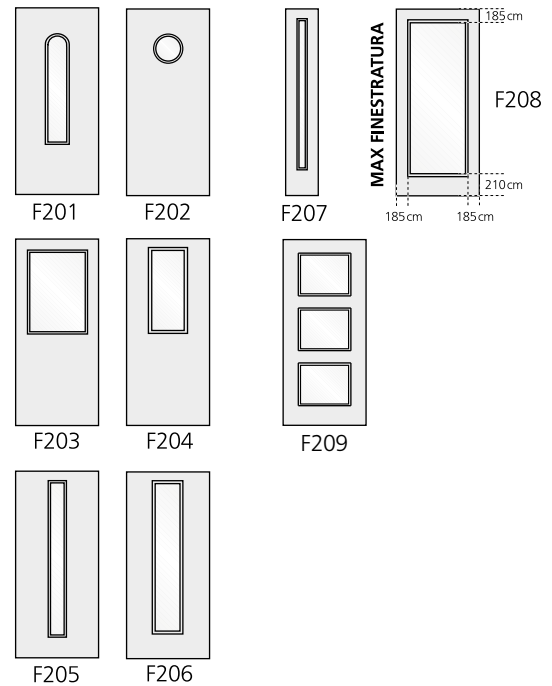

URBAN PANNELLI CON BUGNE E CORNICI

in massello applicate.

Spessore 15 mm



* L'INSTALLAZIONE È CONSENTITA SOLO ALL'OMBRA IN ATRII E PIANEROTTOLI.

Installation allowed in shade, atriums and half spaces. / La instalación está permitida sólo en lugares sombreados, atrios y descansillos.

Wood panels

with applied solid woodframes
and ashlar.
15 mm thickness

Tableros de madera

con concavidad y marcos sobrepuestos
de madera maciza.
Espesor 15 mm

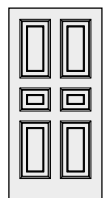

U460

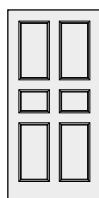

U160

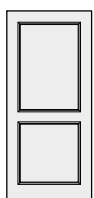

U120

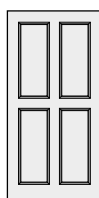

U140

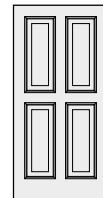

U240 - U240R

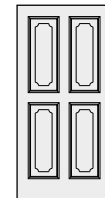

U340 - U340R

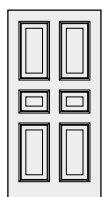

U260 - U260R

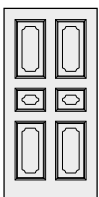

U360 - U360R

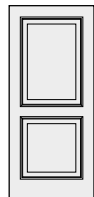

U220 - U220R

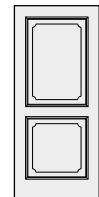

U320 - U320R

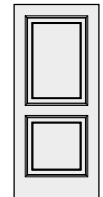

U420

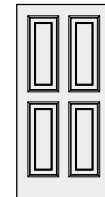

U440

TIPO: 1

U120, U140, U160

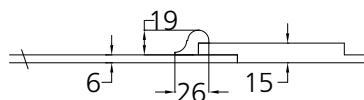

TIPO: 2 - 3

U220, U240, U260,
U320, U340, U360

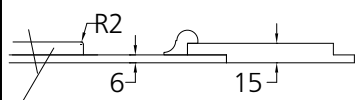

TIPO: 2 - 3 R

U220R, U240R, U260R,
U320R, U340R, U360R

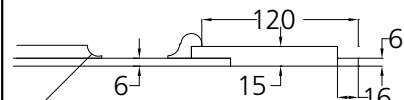

TIPO: 4

U420, U440, U460

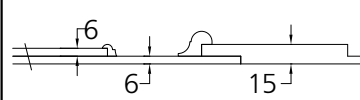

TIPO: 1

U120, U140, U160

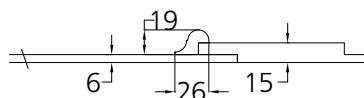

TIPO: 2 - 3

U220, U240, U260,
U320, U340, U360

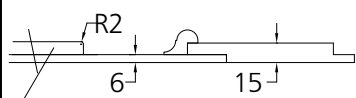

TIPO: 2 - 3 R

U220R, U240R, U260R,
U320R, U340R, U360R

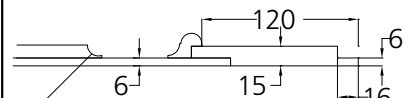

TIPO: 4

U420, U440, U460

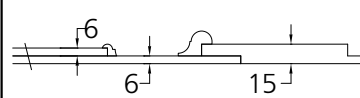

CORNICI APPLICATE NEL RISPETTO DELLA TRADIZIONE ARTIGIANALE.

Applied mouldings according to the handicraft tradition.
Marcos sobrepuestos siguiendo la tradición artesanal.



Ciliegio
Cherry
Cerezo



Mogano
Mahogany
Caoba



Tanganica
Tanganyika
Nogal tanganika



Rovere
Oak
Roble

DIAMANTE PANNELLI IN LEGNO PANTOGRAFATO

a fibre parallele a 90° a doppio strato nobile.

Spessore 15 mm

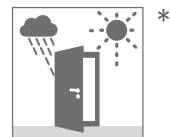

* L'INSTALLAZIONE È CONSENTITA ANCHE ALLA PRESENZA DI SOLE, PIOGGIA E GELO.

Installation is allowed also in the sun, under rain and frost. / La instalación está permitida también bajo el sol, la lluvia y el hielo.

Wood panels

parallel fibres, double noble layer,
90° pantographed panels.
15 mm thickness

Tableros de madera cruzada

con doble capa de madera y ángulos de 90°.
Espesor 15 mm



MOD. A105



MOD. A106



MOD. A107



MOD. A115

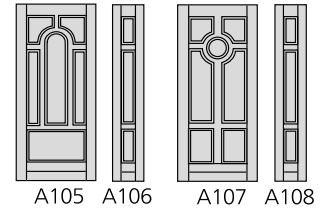

A105 A106

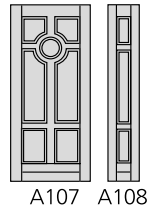

A107 A108

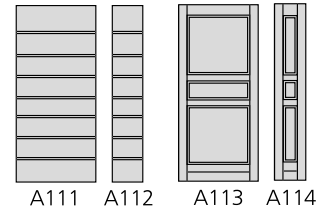

A111 A112

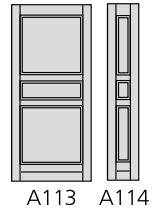

A113 A114

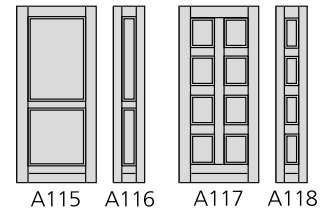

A115 A116

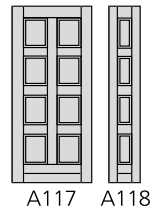

A117 A118

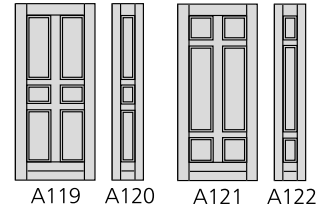

A119 A120

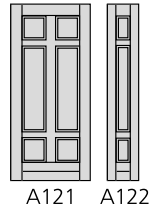

A121 A122

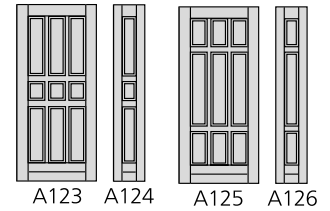

A123 A124

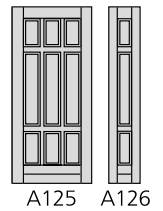

A125 A126

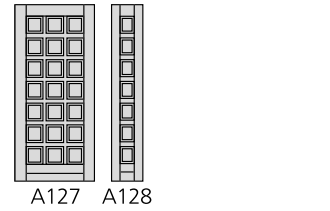

A127 A128



MOD. A111



MOD. A113



MOD. A117

Diamante



MOD. A119



MOD. A121



MOD. A123



MOD. A125



MOD. A127

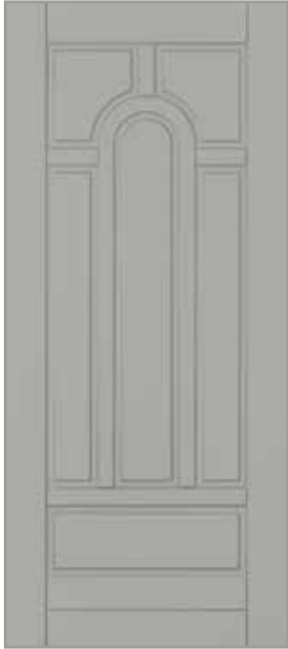

MOD. A105



MOD. A107



MOD. A113

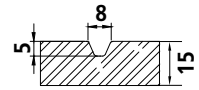
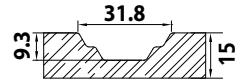

MOD. A111



MOD. A112



MOD. A115

Diamante



MOD. A117



MOD. A119



MOD. A121



MOD. A123



MOD. A125



MOD. A127



FAST PANNELLI IN LEGNO

a fibre parallele monostrato pantografate con angoli stondati.
Spessore 15 mm

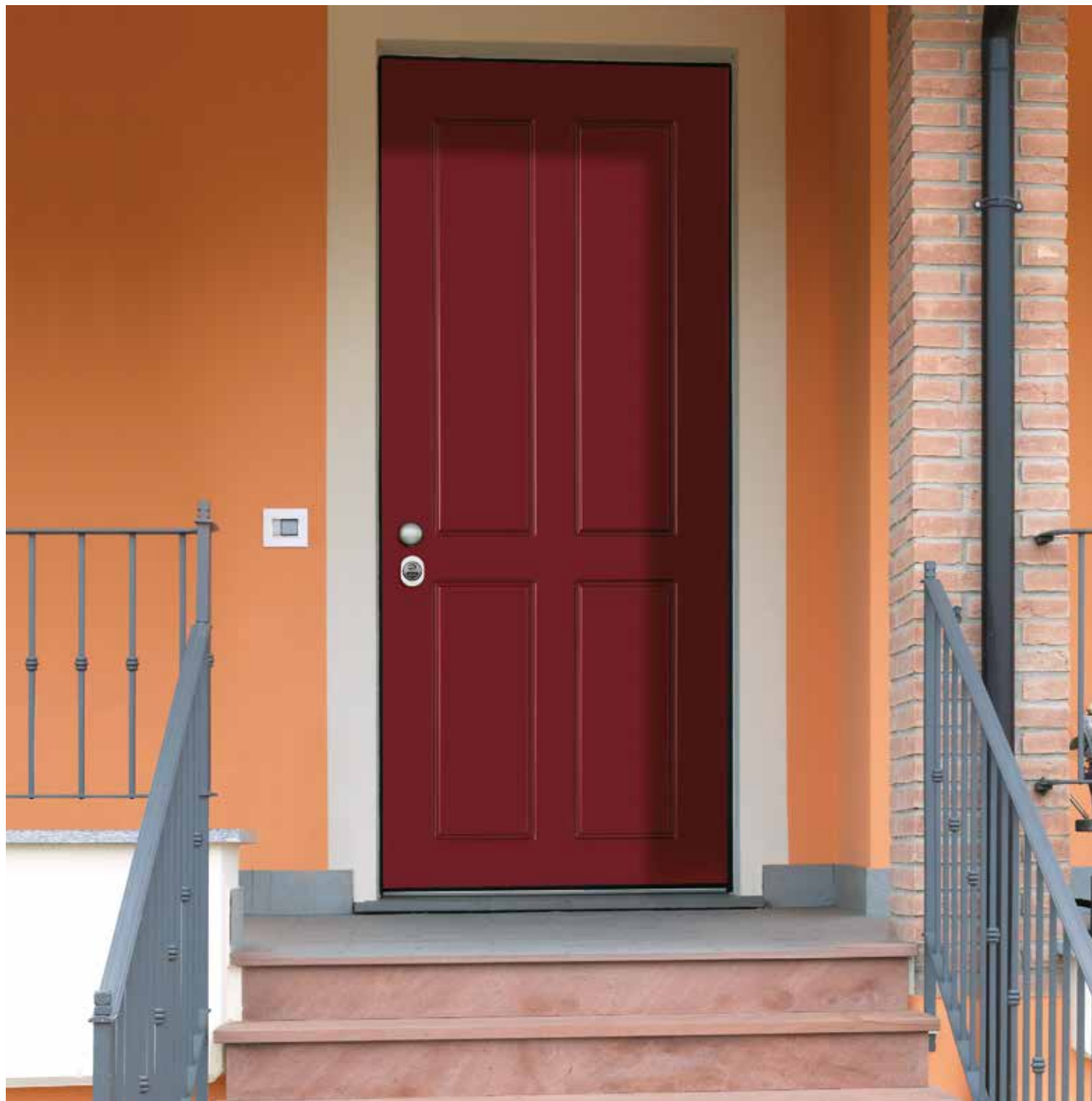
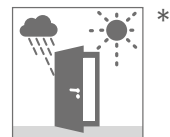

* L'INSTALLAZIONE È CONSENTITA ANCHE ALLA PRESENZA DI SOLE, PIOGGIA E GELO.
Installation is allowed also in the sun, under rain and frost. / La instalación está permitida también bajo el sol, la lluvia y el hielo.

Wood panels

mono layer, rounded angle
pantographed panels.
15 mm thickness

Tableros de madera cruzada

con una capa de madera y cantos redondeados.
Espesor 15 mm

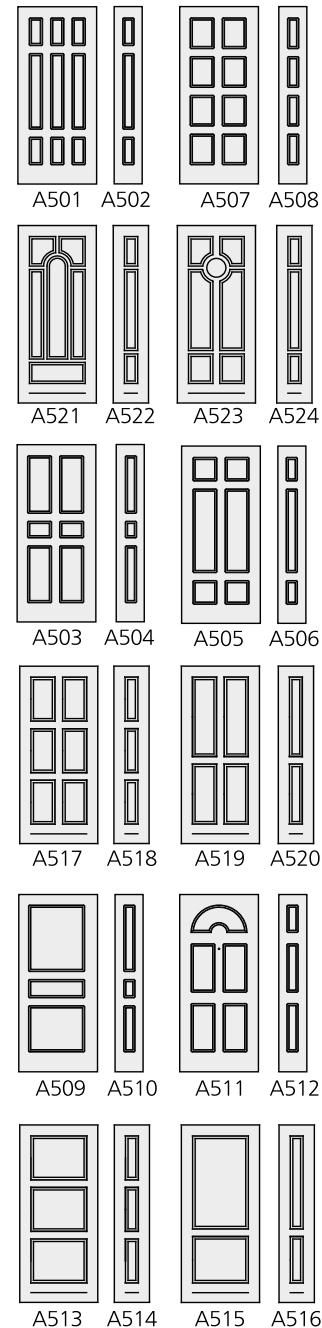
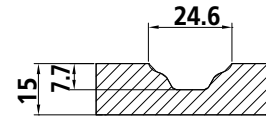

Fast



MOD. A507



MOD. A508



MOD. A511



MOD. A512



MOD. A513



MOD. A514



MOD. A501



MOD. A505



MOD. A515



MOD. A517

Fast



MOD. A517



MOD. A518



MOD. A519



MOD. A520



MOD. A521



MOD. A522



MOD. A503



MOD. A507



MOD. A509



MOD. A513



MOD. A523

PRIMA CLASSE PANNELLI IN LEGNO MASSELLO

Spessore 20 mm

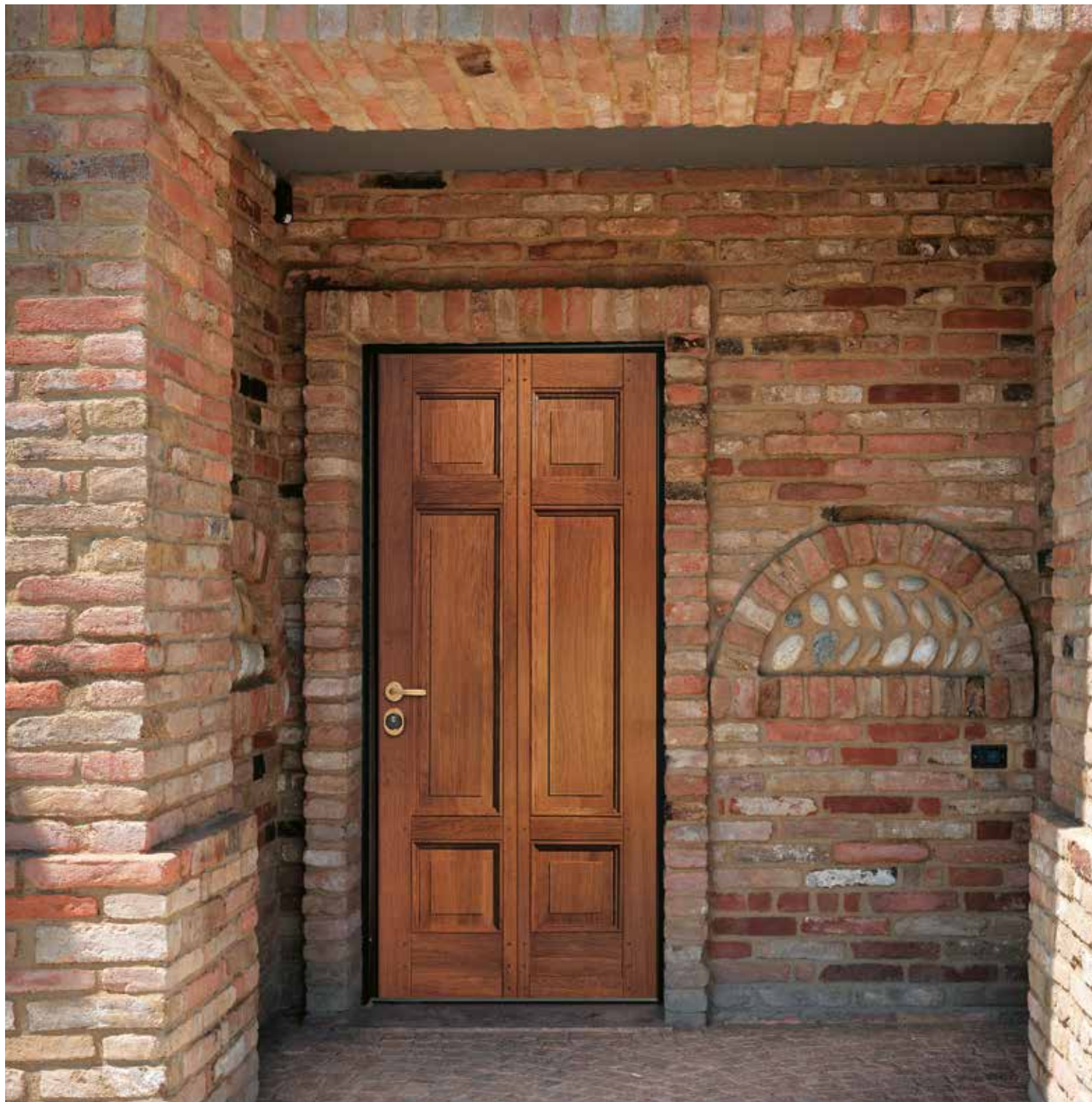

* SI CONSIGLIA L'INSTALLAZIONE DEL RIVESTIMENTO IN POSIZIONE RIPARATA SOTTO LE TETTOIE, PORTICATI E COPERTURE DI ALMENO CM 100.
Paneling installation is suggested in sheltered position under roofs, porches and ceiling of at least cm. 100. / Se aconseja la instalación de los
tableros en lugares amparados debajo de marquesinas, portales y techados de al menos cm 100.

Solid wood panels

20 mm thickness

Tableros de madera maciza

Espesor 20 mm

LA FORZA ED IL CALORE DEL LEGNO MASSELLO
IN UNA COMPOSIZIONE DI INEGUAGLIABILE ELEGANZA.

The strenght and warmth of real wood in a composition of extreme elegance.

La fuerza y el calor de la madera maciza en una composicion de incomparable elegancia.

	Pino Pine Pino	C. Wood	Mogano Mahogany Caoba	Rovere Oak Roble	Rovere Spaz. Oak Roble	Castagno Chestnut Castaño	Ciliegio Cherry Cerezo	Iroko	Douglas	Noce Dan. Walnut Nogal tanganika
A800	•	•	•	•	•	•	•			
A801	•	•	•	•	•	•	•			
A802	•	•	•	•	•	•	•			
A803		•	•	•	•	•	•	•		
A804			•	•		•	•	•		
A805							•	•		
A806			•	•		•	•	•		
A807			•	•		•	•	•		
A808			•	•		•	•	•		
A809		•	•	•		•	•	•		
A810			•	•		•	•	•		
A811		•	•	•		•	•	•		
A812	•	•	•	•		•	•	•	•	•

Prima Classe



MOD. A800



MOD. A801



MOD. A802



MOD. A803



MOD. A804



MOD. A805



MOD. A806



MOD. A807



MOD. A808



MOD. A809



MOD. A810



MOD. A811



MOD. A812

ETERN - ALL PANNELLI IN ALLUMINIO

verniciati a fuoco supportati con MDF idrofugo.

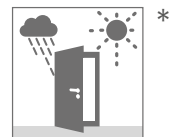

* L'INSTALLAZIONE È CONSENTITA ANCHE ALLA PRESENZA DI SOLE, PIOGGIA E GELO.
Installation is allowed also in the sun, under rain and frost. / La instalación está permitida también bajo el sol, la lluvia y el hielo.

Fire painted aluminium panels
with dampness proof MDF.

Tableros en aluminio
barnizado a fuego con MDF a prueba
de humedad.

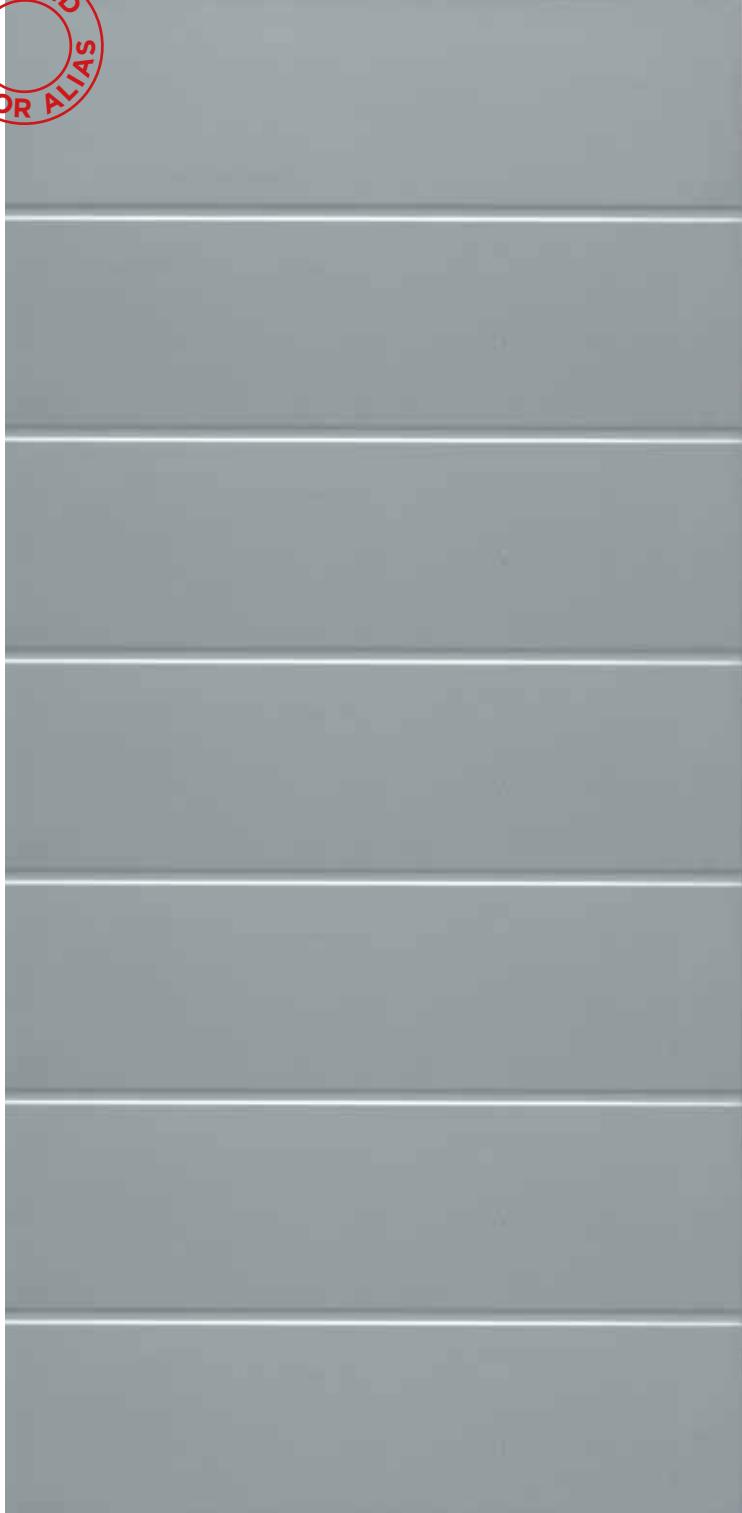

Etern - all

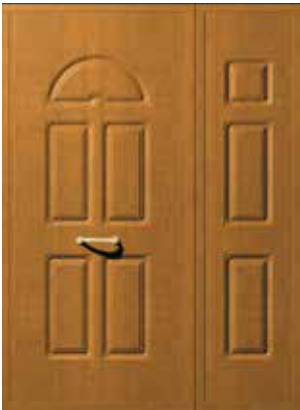

PARIGI

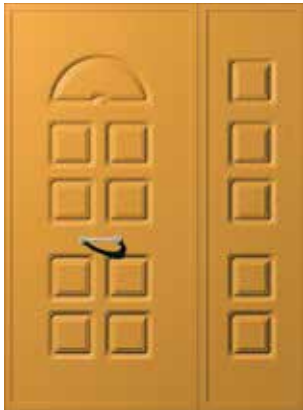

ORLEANS



ANKARA



LIPSIA



BIRMINGHAM



DAMASCO



ISTANBUL



BUCAREST



GRANADA



CORDOBA



VALENCIA



TUAM



RENA



VIGO



FIRENZE



BORDEAUX



DRESDA



PORTO



CRETA



COSTANZA



STETTINO



MALAGA



NIZZA



INNSBRUCK



ANDORRA



BILBAO



SYROS

Etern - all

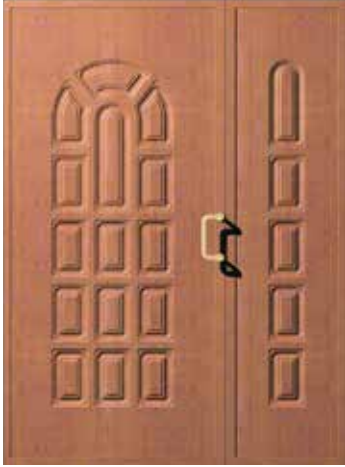

LEEDS



ATENE



LISBONA



BRISTOL



TALLIN



MONTPELLIER



GOTEBORG



MELIDE



BERNA



AMSTERDAM



CADIZ



LUBLIN

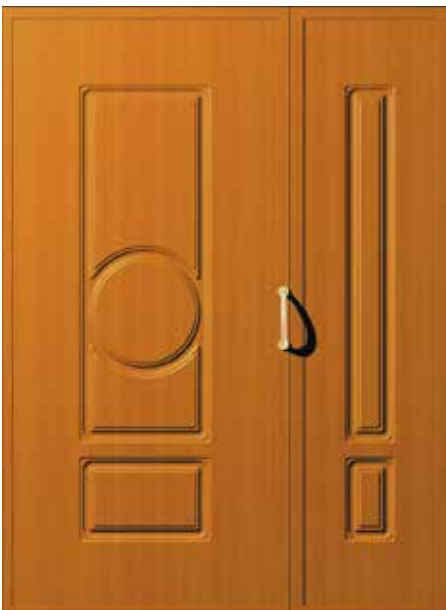

MALMO



TAMPERE



ALBONA



PATRASSO

NAUTILUS

PANNELLI IN ABS LACCATI

e supportati con polistirene espanso.

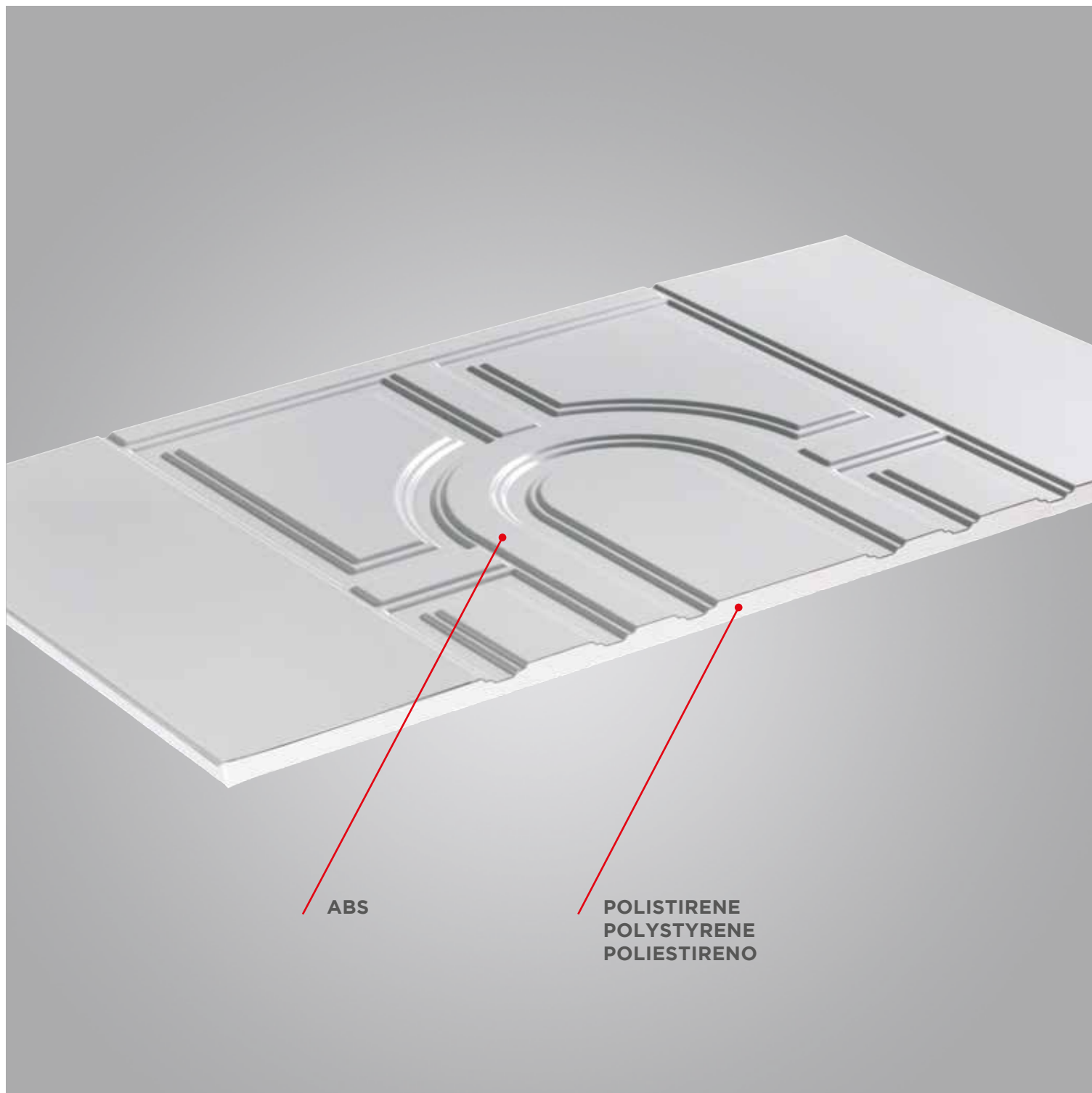
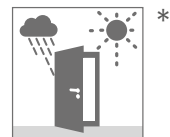

* L'INSTALLAZIONE È CONSENTITA ANCHE ALLA PRESENZA DI SOLE, PIOGGIA E GELO.
Installation is allowed also in the sun, under rain and frost. / La instalación está permitida también bajo el sol, la lluvia y el hielo.

Lacquered ABS panel
supported by expanded polystyrene.

Tableros de ABS laqueados
y soportados con poliestireno expando.

DESIGN E MASSIMA PERFORMANCE ISOLANTE.
CON IL RIVESTIMENTO NAUTILUS LA TRASMITTANZA
TERMICA SI ABBASSA FINO A UN VALORE DI 1,0 W/M² K.

Design and top performance, Nautilus panel grants
a reduction of the thermic trasmittance till a value of 1,0 W/M² K .

Diseño y máxima prestación aislante.
Revestimiento Nautilus permite una reducción
de la transmitancia térmica hasta de 1,0 w/m² k.

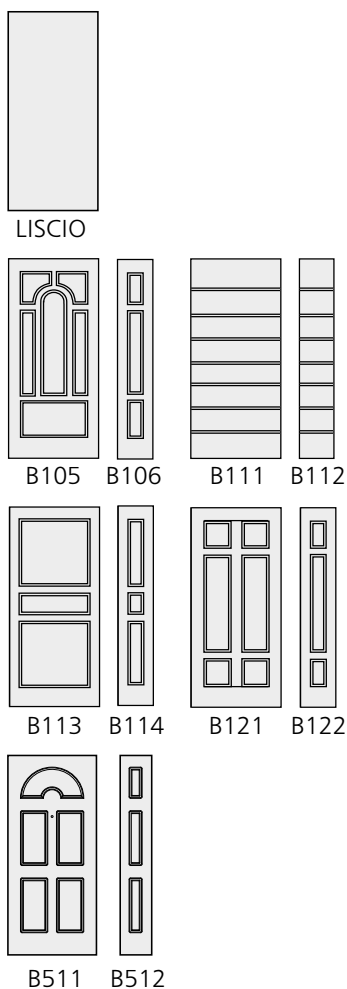

RENO PANNELLI PANTOGRAFATI

e rivestiti con Renolit.

Spessore 12 mm

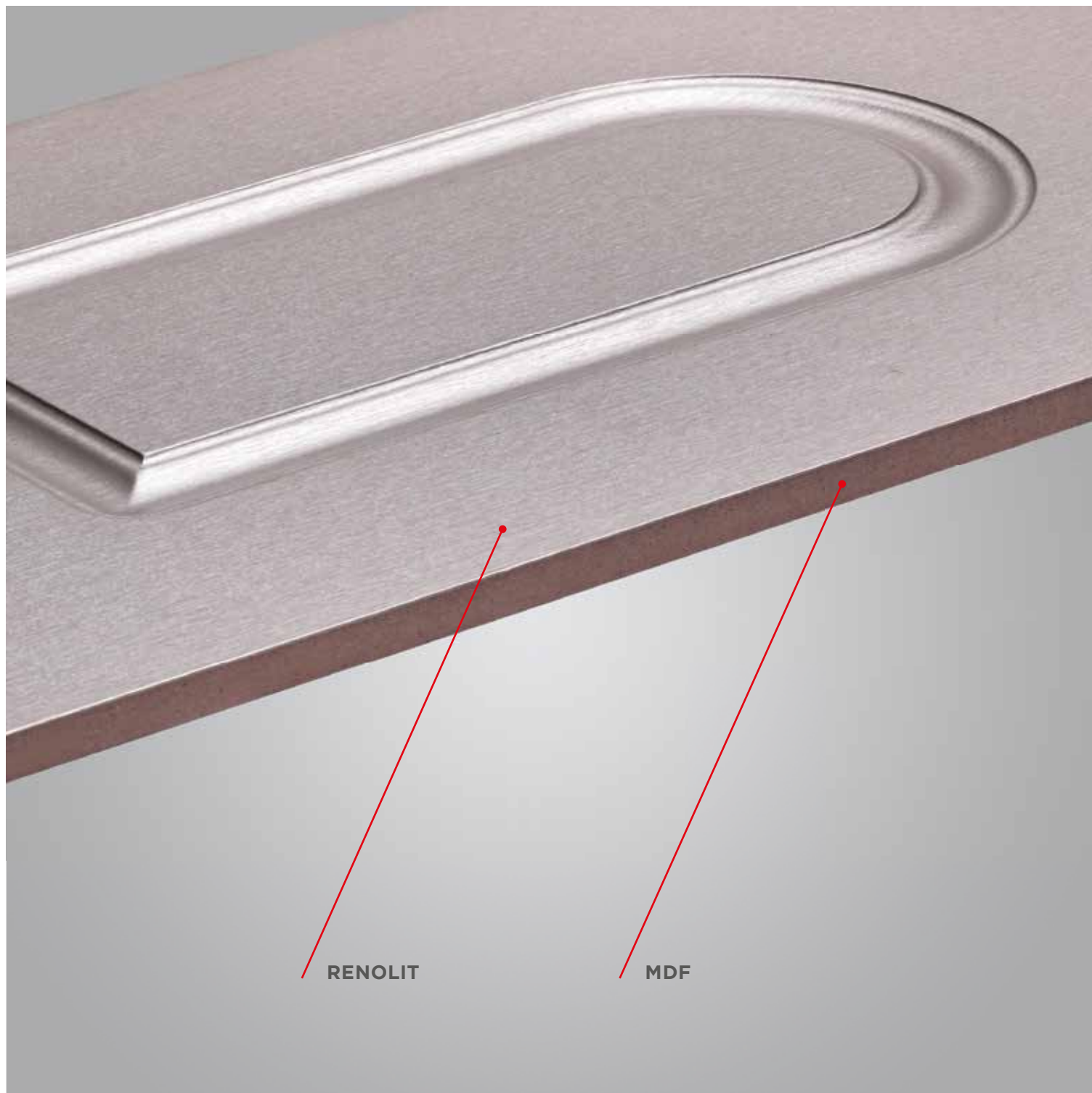
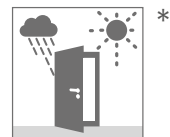

* L'INSTALLAZIONE È CONSENTITA ANCHE ALLA PRESENZA DI SOLE, PIOGGIA E GELO.

Installation is allowed also in the sun, under rain and frost. / La instalación está permitida también bajo el sol, la lluvia y el hielo.

Pantographed panels
coated by Renolit.
12 mm thickness

Tableros pantografiados
y revestidos con Renolit.
Espesor 12 mm



MOD. 138



MOD. 012



MOD. 05-070



MOD. 035



MOD. 016



MOD. 057

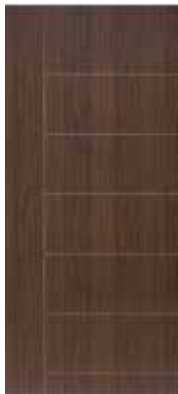

MOD. 076



MOD. 085



MOD. 090



MOD. 091



MOD. 097



MOD. 105



MOD. 183



MOD. 185

Reno



F436-3086
Sheffield Oak grey



F436-5014
Blattgruen



F436-5021
Tanngruen



F436-5036
Lichgrau



F436-5049
Silbergrau

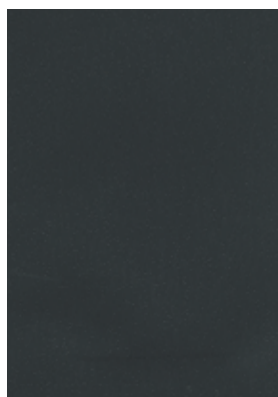

F436-6003
Anthrazitgrau SFTN matt

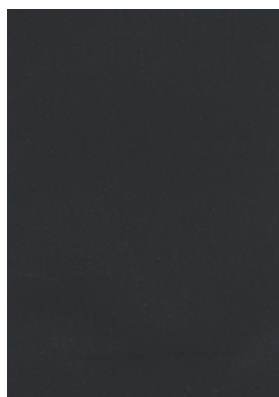

F436-5003
Anthrazitgrau

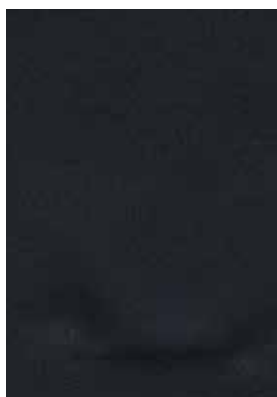

F436-6010
Schwarbraun SFTN matt



F436-6021
Tannengruen sftn matt



F436-6039
Silicia SFTN matt



F436-6047
SFTN matt



F456-3081
Sheffield Oak light



F456-5057
Brillant weiss

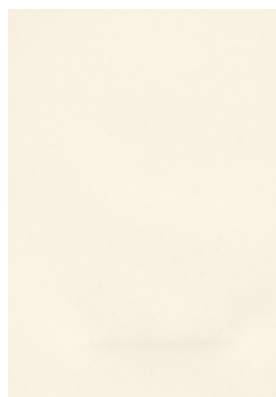

F465-5015
Beige

I COLORI E LE ESSENZE DEI PANNELLI RIPRODOTTI SU QUESTO CATALOGO SONO INDICATIVI E IN NESSUN MODO VINCOLANTI PER ALIAS.
The colors and the essence of the panels that have been reproduced in this catalogue are indicative and they are in no way an obligation for Alias.
Los colores y tipos de maderas de los paneles ilustrados en este catálogo son indicativos, y en ningún modo supondrán compromiso por parte de Alias.



F436-1012
Alux anthrazit



F436-1013
Alux silbergrau



F436-2001
Macoree



F436-2007
Montana Eiche tabak



F436-2022
Anegrè goldbraun



F436-2035
Staufereiche terra



F436-2036
Staufereiche kolonial



F436-2060
Sipo



F436-3031
Birke rosè



F436-3041
Noce Sorrento natur



F436-3042
Noce Sorrent balsamico



F436-3043
Cherry amaretto



F436-3058
Walnus amaretto



F436-3059
Walnuss terra



F436-3077
Newcastle Oak khaki

SHOWROOM

UNA RETE CAPILLARE DI RIVENDITORI, DISTRIBUITA SU TUTTO IL TERRITORIO NAZIONALE E NEI PRINCIPALI PAESI EUROPEI, È A TUA DISPOSIZIONE PER GUIDARTI NELLA SCELTA DELLA TUA DESIGN SECURITY DOOR ALIAS. UN TEAM COMPOSTO DA PROFESSIONISTI COSTANTEMENTE AGGIORNATI, IN GRADO DI OFFRIRTI UN SERVIZIO AFFIDABILE E FATTO SU MISURA, PER RISPONDERE A OGNI TUA ESIGENZA.

An extended resellers network distributed all over Italy and European countries will help you to choose your ALIAS Design Security Door. A team of experts always up dated will offer a custom size and reliable service to answer to any requests.

Una amplia red de distribuidores autorizados, distribuida por todo el territorio Italiano y europeo está a tu disposición para ayudarte en la elección de tu diseño personalizado de las puertas de seguridad ALIAS. Un grupo compuesto por profesionales constantemente actualizados, en grado de ofrecerte un servicio fiable y realizado a medida, para responder a todas tus necesidades.







STRUCTURES SYSTEM

STEEL

CLASSE 3 di antieffrazione UNI-EN 1627
Anti Burglary - Seguridad contra la efracción

TRASMITTANZA TERMICA - 1,3 W/(m².K)
Thermic conduction - Transmitancia termica

ABBATTIMENTO ACUSTICO - 34 dB
Acoustic performance - Aislamiento acustico

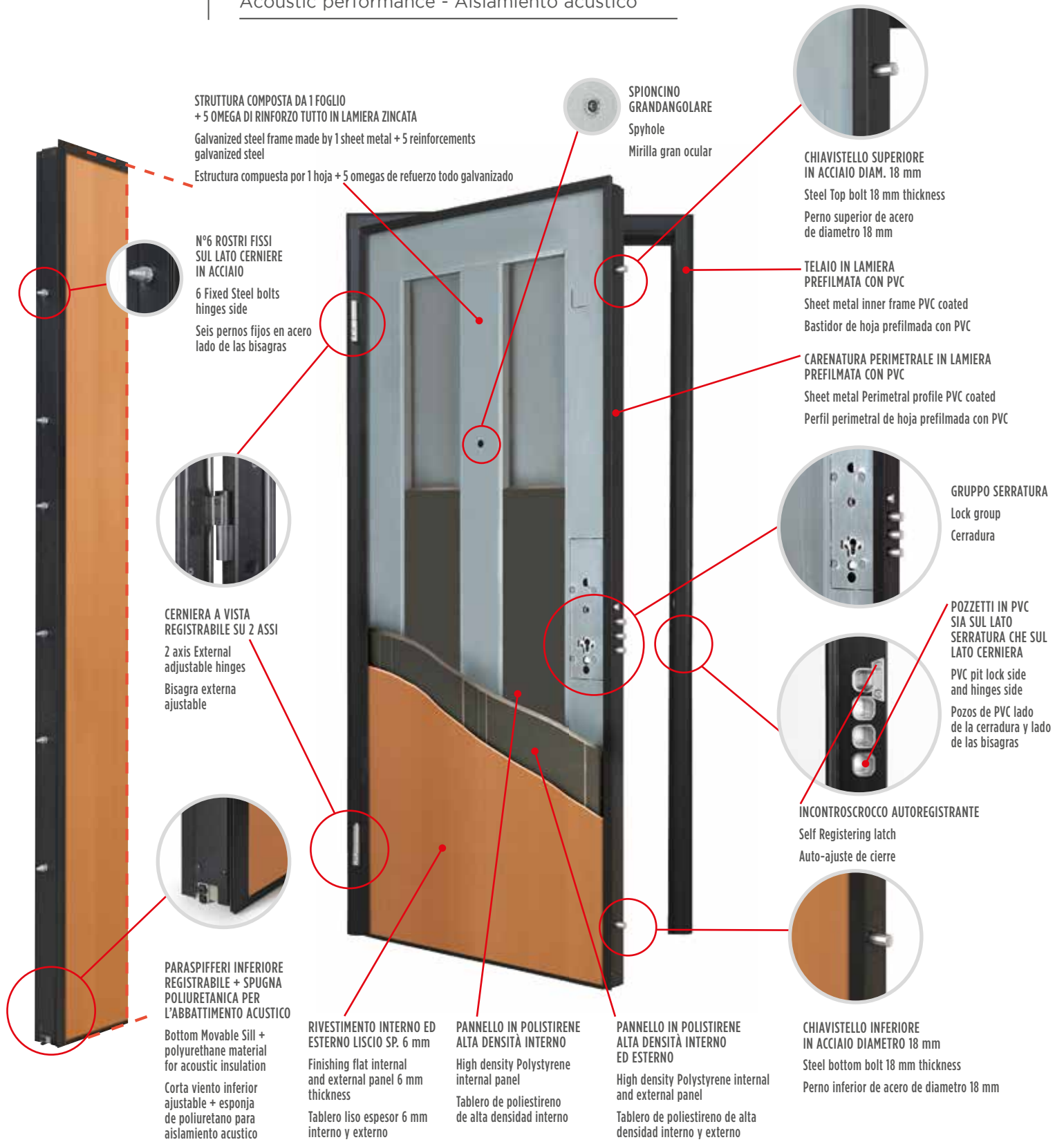

STRUTTURA COMPOSTA DA 1 FOGLIO + 5 OMEGA DI RINFORZO TUTTO IN LAMIERA ZINCATA
Galvanized steel frame made by 1 sheet metal + 5 reinforcements galvanized steel
Estructura compuesta por 1 hoja + 5 omegas de refuerzo todo galvanizado

N°6 ROSTRI FISSI SUL LATO CERNIERE IN ACCIAIO
6 Fixed Steel bolts hinges side
Seis pernos fijos en acero lado de las bisagras



CERNIERA A VISTA REGISTRABILE SU 2 ASSI
2 axis External adjustable hinges
Bisagra externa ajustable



PARASPIFFERI INFERIORE REGISTRABILE + SPUGNA POLIURETANICA PER L'ABBATTIMENTO ACUSTICO
Bottom Movable Sill + polyurethane material for acoustic insulation
Corta viento inferior ajustable + esponja de poliuretano para aislamiento acustico

RIVESTIMENTO INTERNO ED ESTERNO LISCIO SP. 6 mm
Finishing flat internal and external panel 6 mm thickness
Tablero liso espesor 6 mm interno y externo

PANNELLO IN POLISTIRENE ALTA DENSITÀ INTERNO
High density Polystyrene internal panel
Tablero de poliestireno de alta densidad interno

PANNELLO IN POLISTIRENE ALTA DENSITÀ INTERNO ED ESTERNO
High density Polystyrene internal and external panel
Tablero de poliestireno de alta densidad interno y externo

SPIONCINO GRANDANGOLARE
Spyhole
Mirilla gran ocular

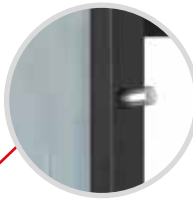

CHIAVISTELLO SUPERIORE IN ACCIAIO DIAM. 18 mm
Steel Top bolt 18 mm thickness
Perno superior de acero de diametro 18 mm

TELAIO IN LAMIERA PREFILMATA CON PVC
Sheet metal inner frame PVC coated
Bastidor de hoja prefilmada con PVC

CARENATURA PERIMETRALE IN LAMIERA PREFILMATA CON PVC
Sheet metal Perimetral profile PVC coated
Perfil perimetral de hoja prefilmada con PVC



GRUPPO SERRATURA
Lock group
Cerradura



POZZETTI IN PVC SIA SUL LATO SERRATURA CHE SUL LATO CERNIERA
PVC pit lock side and hinges side
Pozos de PVC lado de la cerradura y lado de las bisagras

INCONTROSCROCCO AUTOREGISTRANTE
Self Registering latch
Auto-ajuste de cierre

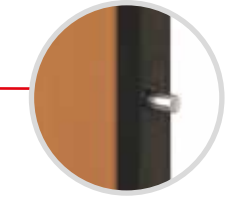

CHIAVISTELLO INFERIORE IN ACCIAIO DIAMETRO 18 mm
Steel bottom bolt 18 mm thickness
Perno inferior de acero de diametro 18 mm

VERSIONI

Versions
Versiones

Steel N



DOPPIA MAPPA NON RICIFRABILE
Non recordable Double bit
Cerradura doble mapa
sin recodificaciòn

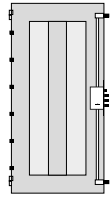

Steel R



**DOPPIA MAPPA RICIFRABILE
(CAMBIO FACILE CISA)**
Recordable Double bit
Cerradura doble mapa
con recodificaciòn

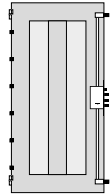

Steel C



CILINDRO EUROPEO
European Cylinder profile
Cerradura con cilindro

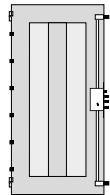

Steel CY



**CILINDRO EUROPEO
+ CILINDRO DI SERVIZIO**
European Cylinder profile
+ Service cylinder
Cerradura con cilindro
+ cerradura de servicio

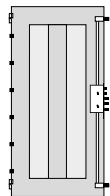

MISURE STANDARD

Standard Measures
Medidas estandar

Larghezza / Width / Anchura:
cm 80 - 85 - 90

Altezza / Height / Altura:
cm 210

FUORI MISURA REALIZZABILI

Possible out of standard

Medidas no estandar que se pueden realizar

Larghezza / Width / Anchura:
da cm 50 a cm 110
from 50 cm to 110 cm
desde 50 cm hasta 110 cm

Altezza / Height / Altura:
da cm 180 a cm 250
from 180 cm to 250 cm
desde 180 cm hasta 250 cm

Steel CS



**DOPPIO CILINDRO EUROPEO
CON BLOCCO**
Double European Cylinder profile
with security lock
Cerradura con doble cilindro
y bloqueo

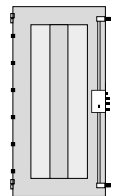

MANIGLIERIA DI SERIE

Standard Handles - Manillas estandar

ALLUMINIO BRONZATO
Bronze aluminium
Aluminio bronceado



ARGENTO
Silver
Plateado



OTTONE
Brass
Latòn



MANIGLIERIA OPTIONAL

Optional handles - Manillas opcionales

CROMO SATINATO
Matt chrome
Satinado cromado



FENIX

CROMO SATINATO
Matt chrome
Satinado cromado



CROMO LUCIDO
Bright chrome
Cromado brillante



MANIGLIONI
Fixed handle
Barra fija externa



46 cm 116 cm

STEEL PLUS

CLASSE 3 di antieffrazione UNI-EN 1627
Anti Burglary - Seguridad contra la efracción

TRASMITTANZA TERMICA - 1,3 W/(M².K)
Thermic conduction - Transmitancia termica

ABBATTIMENTO ACUSTICO - 34 dB
Acoustic performance - Aislamiento acustico

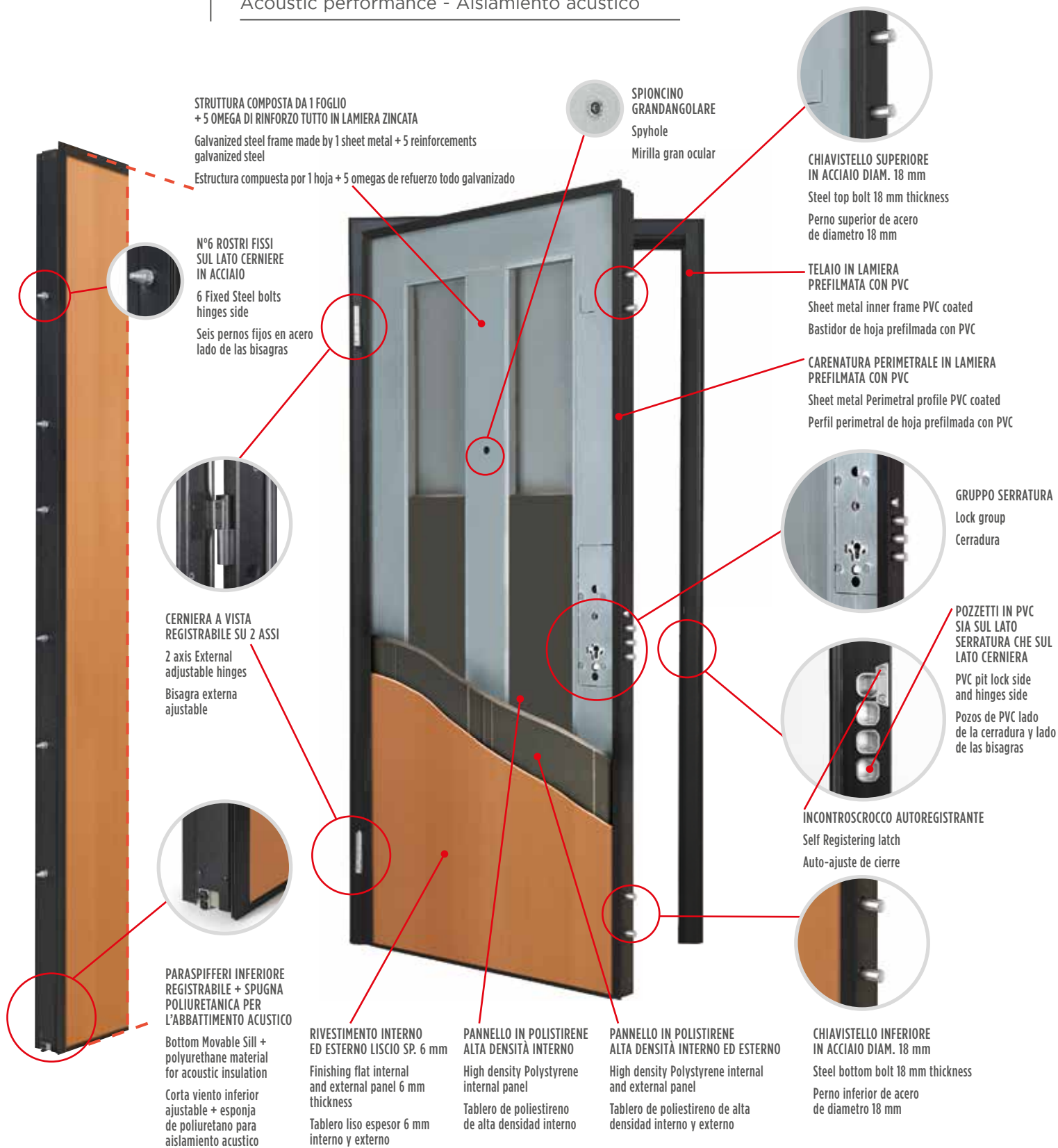

VERSIONI

Versions

Versiones

Steel C Plus



CILINDRO EUROPEO (CAMBIO FACILE CISA)
CON DOPPIO DEVIATORE INFERIORE
E SUPERIORE

European Cylinder with double
top and bottom bolts

Cerradura con cilindro
+ doble perno inferior y superior

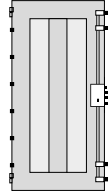

Steel CY Plus



CILINDRO EUROPEO
+ CILINDRO DI SERVIZIO

European Cylinder profile
+ Service cylinder

Cerradura con cilindro
+ cerradura de servicio

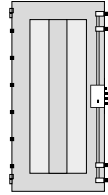

Steel CS Plus



CILINDRO EUROPEO
+ CILINDRO DI SERVIZIO

European Cylinder profile
+ Service cylinder

Cerradura con cilindro
+ cerradura de servicio

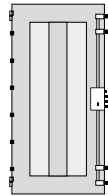

MISURE STANDARD

Standard Measures

Medidas estandar

Larghezza / Width / Anchura:

cm 80 - 85 - 90

Altezza / Height / Altura:

cm 210

FUORI MISURA REALIZZABILI

Possible out of standard

Medidas no estandar que se pueden realizar

Larghezza / Width / Anchura:

da cm 50 a cm 110

from 50 cm to 110 cm

desde 50 cm hasta 110 cm

Altezza / Height / Altura:

da cm 180 a cm 250

from 180 cm to 250 cm

desde 180 cm hasta 250 cm

MANIGLIERIA DI SERIE

Standard Handles - Manillas estandar

ALLUMINIO BRONZATO

Bronze aluminium
Aluminio bronceado



ARGENTO

Silver
Plateado



OTTONE

Brass
Latón



MANIGLIERIA OPTIONAL

Optional handles - Manillas opcionales

CROMO SATINATO

Matt chrome
Satinado cromado



FENIX

CROMO SATINATO

Matt chrome
Satinado cromado



CROMO LUCIDO

Bright chrome
Cromado brillante



MANIGLIONI

Fixed handle
Barra fija externa



46 cm 116 cm

VEGA PLUS

CLASSE 4 di antieffrazione UNI-EN 1627
Anti Burglary - Seguridad contra la efracción

TRASMITTANZA TERMICA - 1,8 W/(M².K)
Thermic conduction - Transmitancia termica

ABBATTIMENTO ACUSTICO - 34 dB
Acoustic performance - Aislamiento acustico

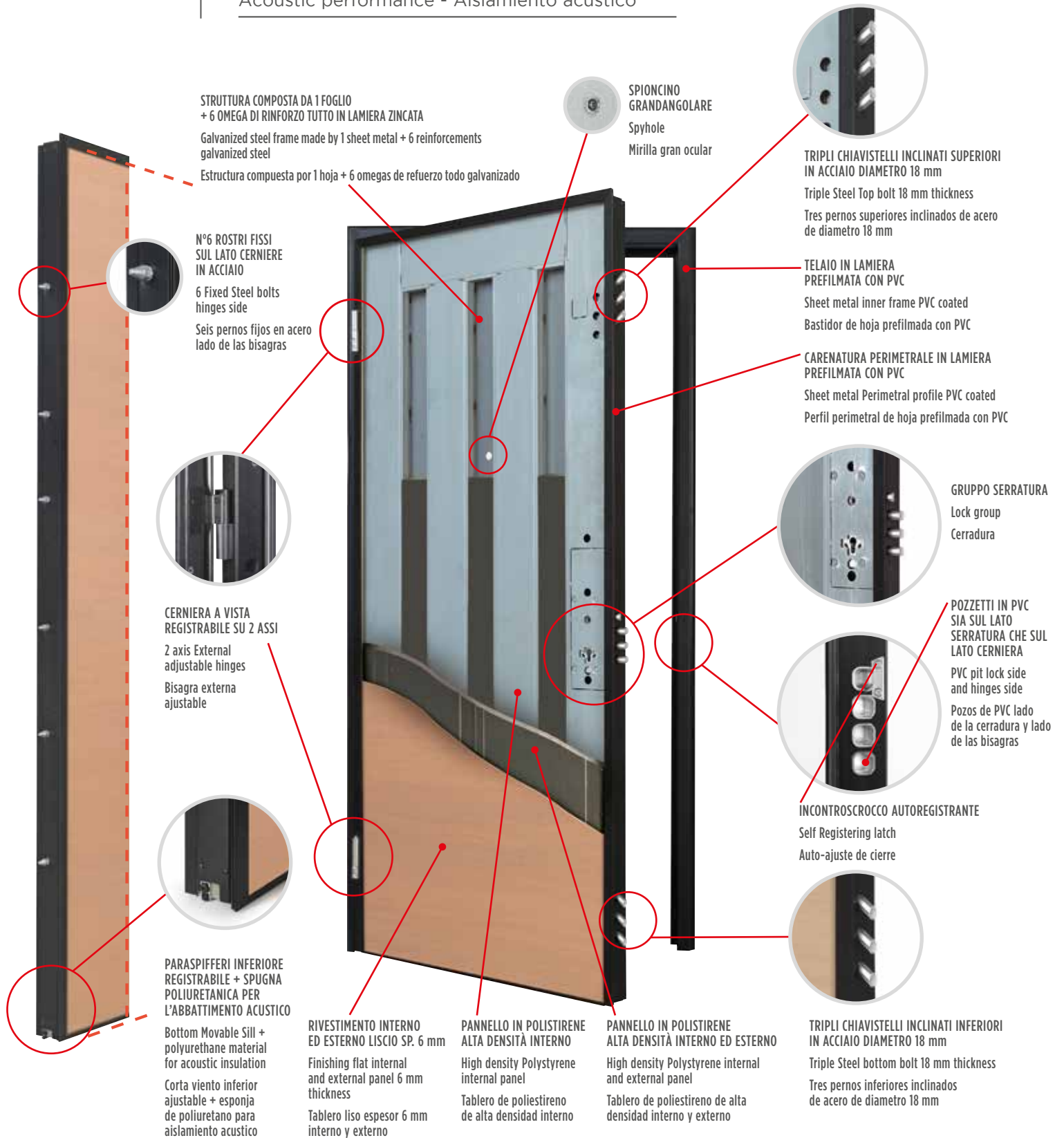

VERSIONI

Versions

Versiones

Vega Plus C



CILINDRO EUROPEO
European Cylinder profile
Cerradura con cilindro

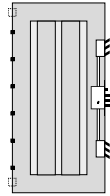

Vega Plus CS



DOPPIO CILINDRO EUROPEO
CON BLOCCO
Double European Cylinder profile
with security lock
Cerradura con doble cilindro
y bloqueo

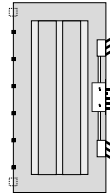

MISURE STANDARD

Standard Measures
Medidas estandar

Larghezza / Width / Anchura:
cm 80 - 85 - 90

Altezza / Height / Altura:
cm 210

FUORI MISURA REALIZZABILI

Possible out of standard

Medidas no estandar que se pueden realizar

Larghezza / Width / Anchura:
da cm 50 a cm 110
from 50 cm to 110 cm
desde 50 cm hasta 110 cm

Altezza / Height / Altura:
da cm 180 a cm 250
from 180 cm to 250 cm
desde 180 cm hasta 250 cm

MANIGLIERIA DI SERIE

Standard Handles - Manillas estandar

ALLUMINIO BRONZATO

Bronze aluminium
Aluminio bronceado



ARGENTO

Silver
Plateado



OTTONE

Brass
Latón



MANIGLIERIA OPTIONAL

Optional handles - Manillas opcionales

CROMO SATINATO

Matt chrome
Satinado cromado



FENIX

CROMO SATINATO

Matt chrome
Satinado cromado



CROMO LUCIDO

Bright chrome
Cromado brillante



MANIGLIONI

Fixed handle
Barra fija externa



46 cm 116 cm

STEEL FB6

**RESISTENZA AL PROIETTILE EN 1522
FB6 FINO AL CALIBRO 7,62 X 51 FJ**

Bullet resistance FB6 till Caliber 7.62x51 FJ
according to rule EN1522

Resistencia antibalas a norma
en 1522 hasta el calibre 7,62 x 51 FJ

CLASSE 3 di antieffrazione UNI-EN 1627
Anti Burglary - Seguridad contra la efracción

TRASMITTANZA TERMICA - 1,8 W/(M².K)
Thermic conduction - Transmitancia termica

ABBATTIMENTO ACUSTICO - 34 dB
Acoustic performance - Aislamiento acustico

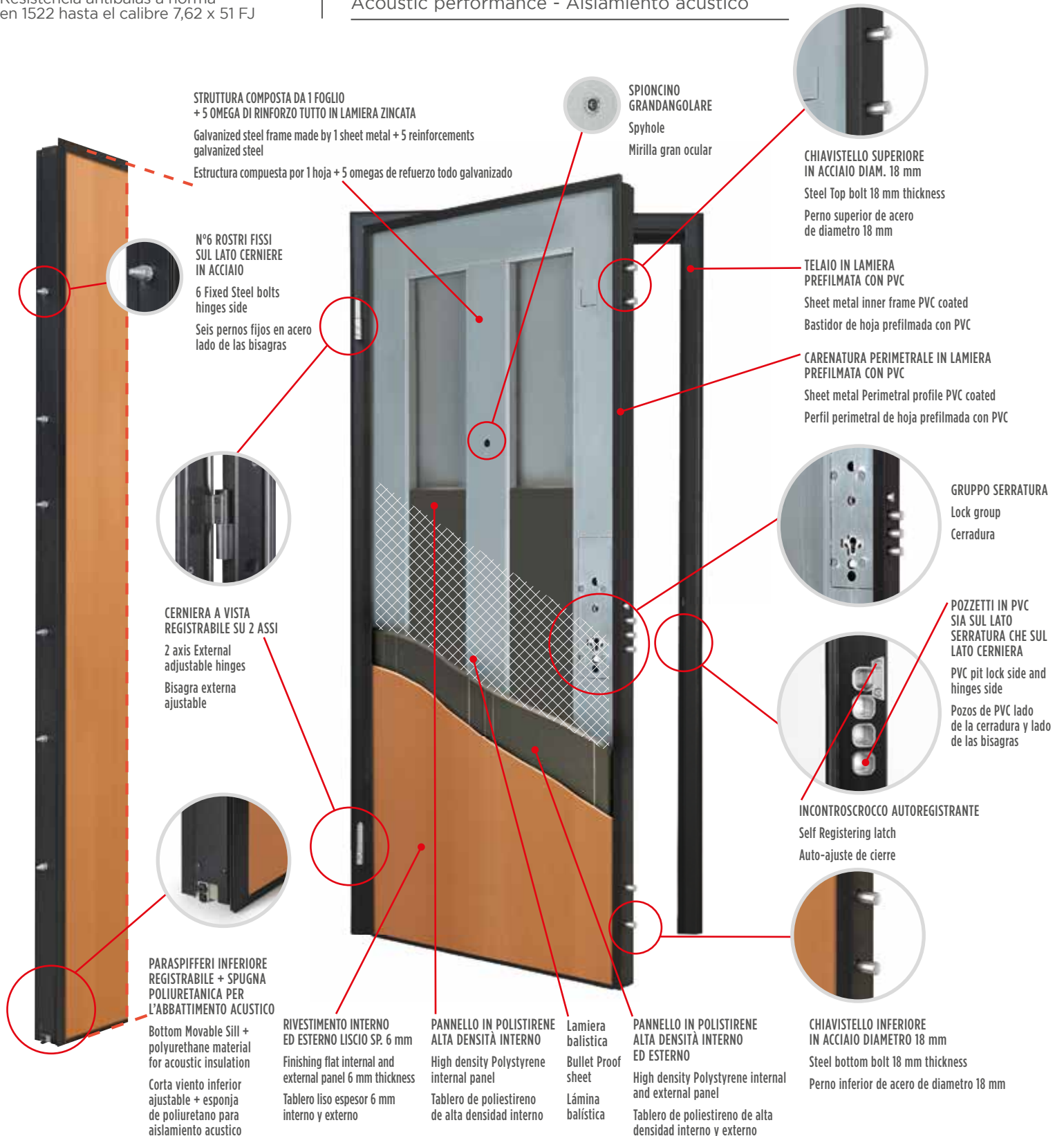

**SEZIONE ORIZZONTALE
NODO LATO SERRATURA**
Horizontal section lock side
Sección horizontal - nudo lado cerradura

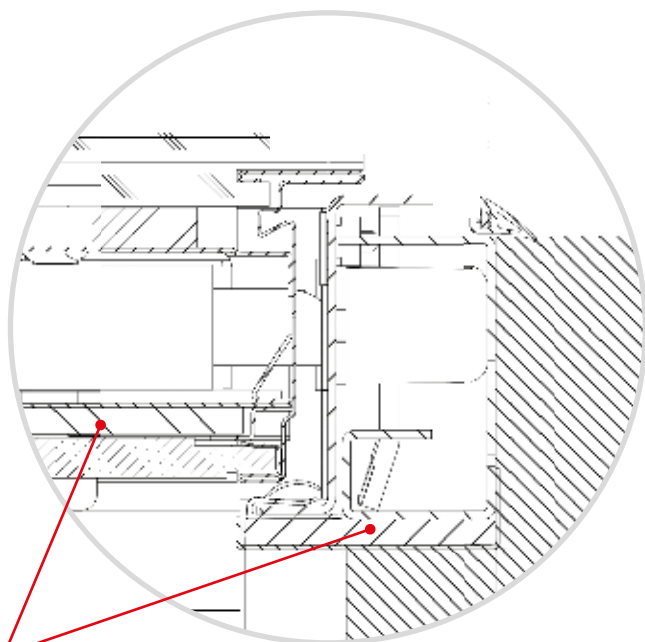

Lamiera balistica
Bullet Proof sheet
Lámina balística

MISURE STANDARD

Standard Measures
Medidas estandar

Larghezza / Width / Anchura:
cm 80 - 85 - 90

Altezza / Height / Altura:
cm 210

FUORI MISURA REALIZZABILI

Possible out of standard
Medidas no estandar que se pueden realizar

Larghezza / Width / Anchura:
da cm 50 a cm 110
from 50 cm to 110 cm
desde 50 cm hasta 110 cm

Altezza / Height / Altura:
da cm 180 a cm 250
from 180 cm to 250 cm
desde 180 cm hasta 250 cm

MANIGLIERIA DI SERIE
Standard Handles - Manillas estandar

ALLUMINIO BRONZATO
Bronze aluminium
Aluminio bronceado



ARGENTO
Silver
Plateado



OTTONE
Brass
Latón



MANIGLIERIA OPTIONAL
Optional handles - Manillas opcionales

CROMO SATINATO
Matt chrome
Satinado cromado

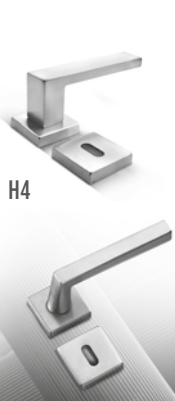

FENIX

CROMO SATINATO
Matt chrome
Satinado cromado



CROMO LUCIDO
Bright chrome
Cromado brillante



MANIGLIONI
Fixed handle
Barra fija externa



46 cm 116 cm

DUO

CLASSE 3 di antieffrazione UNI-EN 1627
Anti Burglary - Seguridad contra la efracción

NOVITÀ

TRASMITTANZA TERMICA - 1,5 W/(m².K)
Thermic conduction - Transmitancia termica

ABBATTIMENTO ACUSTICO - 31 dB
Acoustic performance - Aislamiento acustico

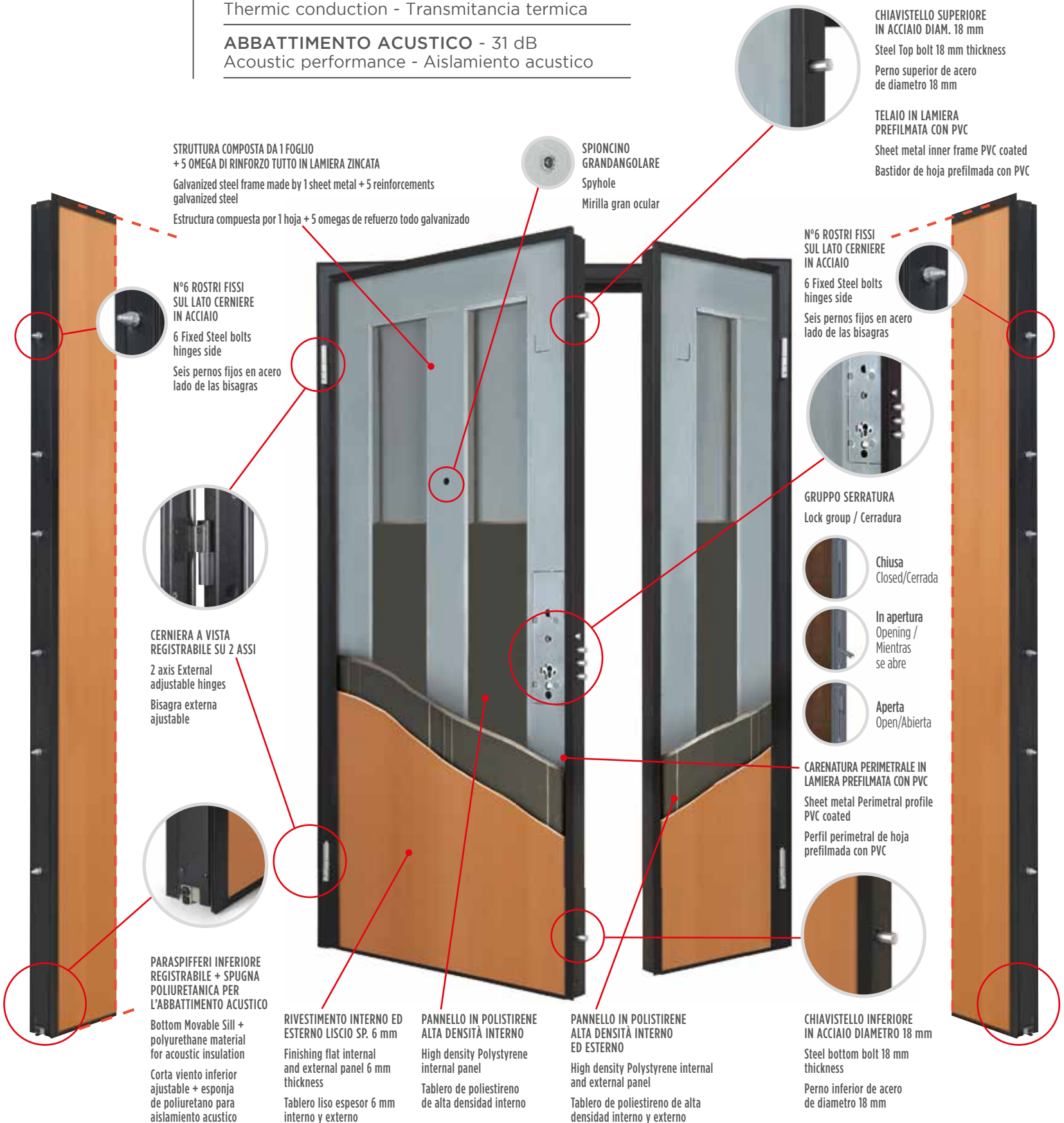

STRUTTURA COMPOSTA DA 1 FOGLIO + 5 OMEGA DI RINFORZO TUTTO IN LAMIERA ZINCATA
Galvanized steel frame made by 1 sheet metal + 5 reinforcements galvanized steel
Estructura compuesta por 1 hoja + 5 omegas de refuerzo todo galvanizado

N°6 ROSTRI FISSI SUL LATO CERNIERE IN ACCIAIO
6 Fixed Steel bolts hinges side
Seis pernos fijos en acero lado de las bisagras

CERNIERA A VISTA REGISTRABILE SU 2 ASSI
2 axis External adjustable hinges
Bisagra externa ajustable

PARASPIFFERI INFERIORE REGISTRABILE + SPUGNA POLIURETANICA PER L'ABBATTIMENTO ACUSTICO
Bottom Movable Sill + polyurethane material for acoustic insulation
Corta viento inferior ajustable + esponja de poliuretano para aislamiento acustico

RIVESTIMENTO INTERNO ED ESTERNO LISCIO SP. 6 mm
Finishing flat internal and external panel 6 mm thickness
Tablero liso espesor 6 mm interno y externo

PANNELLO IN POLISTIRENE ALTA DENSITÀ INTERNO
High density Polystyrene internal panel
Tablero de poliestireno de alta densidad interno

PANNELLO IN POLISTIRENE ALTA DENSITÀ INTERNO ED ESTERNO
High density Polystyrene internal and external panel
Tablero de poliestireno de alta densidad interno y externo

SPIONCINO GRANDANGOLARE
Spyhole
Mirilla gran ocular

CHIAVISTELLO SUPERIORE IN ACCIAIO DIAM. 18 mm
Steel Top bolt 18 mm thickness
Perno superior de acero de diametro 18 mm

TELAIO IN LAMIERA PREFILMATA CON PVC
Sheet metal inner frame PVC coated
Bastidor de hoja prefilmada con PVC

N°6 ROSTRI FISSI SUL LATO CERNIERE IN ACCIAIO
6 Fixed Steel bolts hinges side
Seis pernos fijos en acero lado de las bisagras

GRUPPO SERRATURA
Lock group / Cerradura

Chiusa
Closed/Cerrada

In apertura
Opening / Mientras se abre

Aperta
Open/Abierta

CARENATURA PERIMETRALE IN LAMIERA PREFILMATA CON PVC
Sheet metal Perimetral profile PVC coated
Perfil perimetral de hoja prefilmada con PVC

CHIAVISTELLO INFERIORE IN ACCIAIO DIAMETRO 18 mm
Steel bottom bolt 18 mm thickness
Perno inferior de acero de diametro 18 mm

VERSIONI

Versions

Versiones

Duo R



**DOPPIA MAPPA RICIFRABILE
(CAMBIO FACILE CISA)**

Recordable Double bit
Cerradura doble mapa
con recodificaciòn

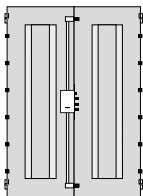

Duo C



CILINDRO EUROPEO
European Cylinder profile
Cerradura con cilindro

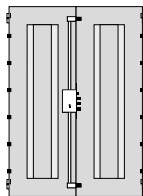

Optional



**CILINDRO EUROPEO
+ CILINDRO DI SERVIZIO**
European Cylinder profile
+ Service cylinder
Cerradura con cilindro
+ cerradura de servicio

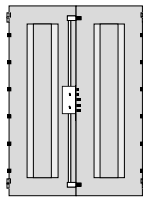

MISURE STANDARD

Standard Measures

Medidas estandar

Larghezza asimmetrica/ Asymmetrical width

Anchura para puerta asimetrica:

cm 80 - 85 - 90 + cm 30 - 35 - 40

Larghezza simmetrica/ Symmetrical width

Anchura para puerta simetrica:

cm 50 - 60 - 65 + cm 50 - 60 - 65

Altezza / Height / Altura:

cm 210

FUORI MISURA REALIZZABILI

Possible out of standard

Medidas no estandar que se pueden realizar

Larghezza / Width / Anchura:

da cm 50 a cm 110

from 50 cm to 110 cm

desde 50 cm hasta 110 cm

Altezza / Height / Altura:

da cm 180 a cm 250

from 180 cm to 250 cm

desde 180 cm hasta 250 cm

MANIGLIERIA DI SERIE

Standard Handles - Manillas estandar

ALLUMINIO BRONZATO

Bronze aluminium
Aluminio bronceado



ARGENTO

Silver
Plateado



OTTONE

Brass
Latòn



MANIGLIERIA OPTIONAL

Optional handles - Manillas opcionales

CROMO SATINATO

Matt chrome
Satinado cromado

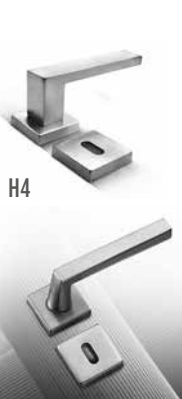

FENIX

CROMO SATINATO

Matt chrome
Satinado cromado



CROMO LUCIDO

Bright chrome
Cromado brillante



MANIGLIONI

Fixed handle
Barra fija externa



46 cm 116 cm

SILVER

CLASSE 3 di antieffrazione UNI-EN 1627
Anti Burglary - Seguridad contra la efracción

TRASMITTANZA TERMICA - 1,3 W/(M².K)
Thermic conduction - Transmitancia termica

ABBATTIMENTO ACUSTICO - 34 dB
Acoustic performance - Aislamiento acustico

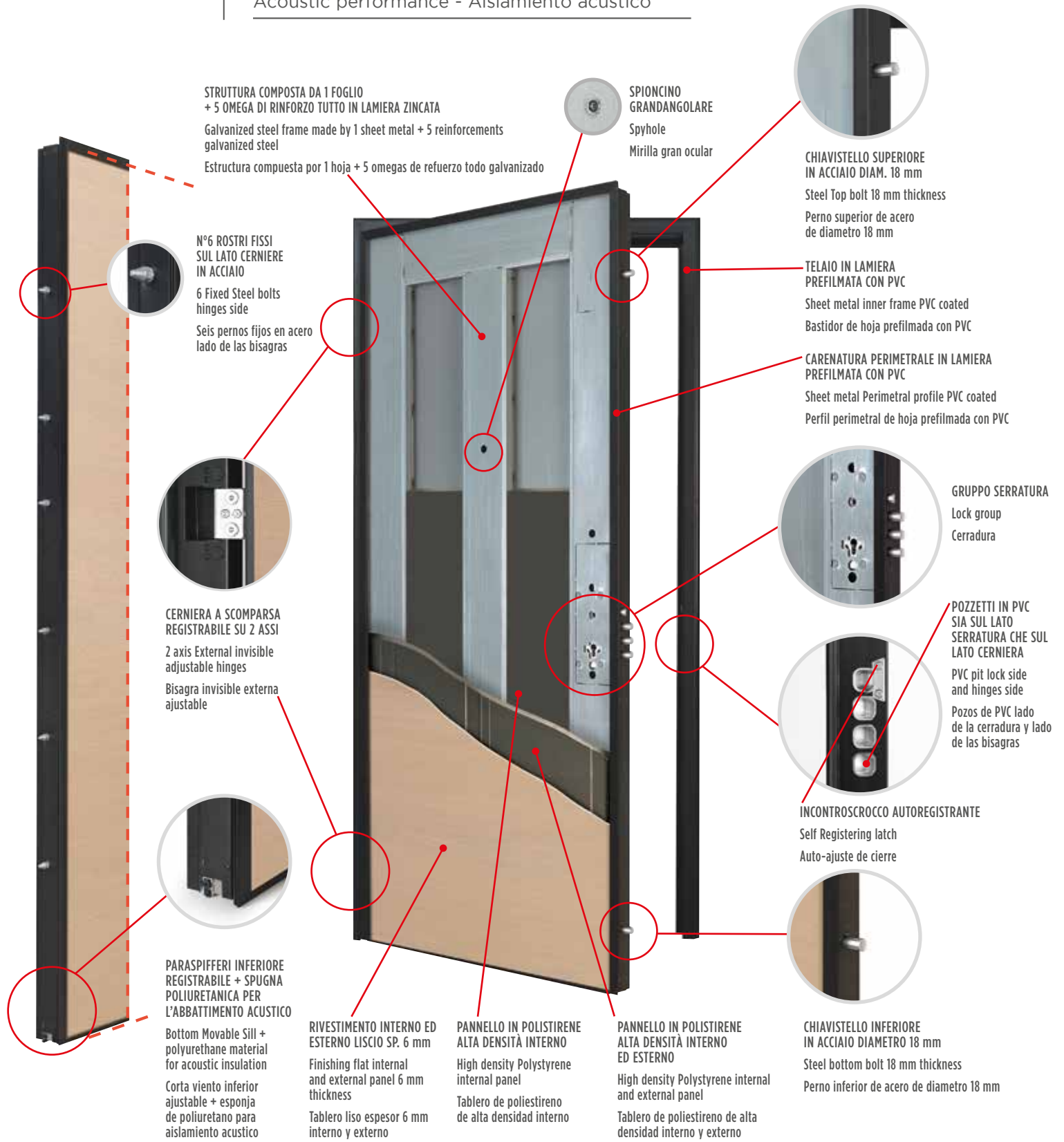

STRUTTURA COMPOSTA DA 1 FOGLIO + 5 OMEGA DI RINFORZO TUTTO IN LAMIERA ZINCATA
Galvanized steel frame made by 1 sheet metal + 5 reinforcements galvanized steel
Estructura compuesta por 1 hoja + 5 omegas de refuerzo todo galvanizado

SPIONCINO GRANDANGOLARE
Spyhole
Mirilla gran ocular

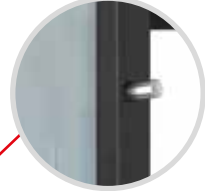

CHIAVISTELLO SUPERIORE IN ACCIAIO DIAM. 18 mm
Steel Top bolt 18 mm thickness
Perno superior de acero de diametro 18 mm

N°6 ROSTRI FISSI SUL LATO CERNIERE IN ACCIAIO
6 Fixed Steel bolts hinges side
Seis pernos fijos en acero lado de las bisagras

TELAIO IN LAMIERA PREFILMATA CON PVC
Sheet metal inner frame PVC coated
Bastidor de hoja prefilmada con PVC

CARENATURA PERIMETRALE IN LAMIERA PREFILMATA CON PVC
Sheet metal Perimetral profile PVC coated
Perfil perimetral de hoja prefilmada con PVC



CERNIERA A SCOMPARSA REGISTRABILE SU 2 ASSI
2 axis External invisible adjustable hinges
Bisagra invisible externa ajustable



GRUPPO SERRATURA
Lock group
Cerradura



POZZETTI IN PVC SIA SUL LATO SERRATURA CHE SUL LATO CERNIERA
PVC pit lock side and hinges side
Pozos de PVC lado de la cerradura y lado de las bisagras



PARASPIFFERI INFERIORE REGISTRABILE + SPUGNA POLIURETANICA PER L'ABBATTIMENTO ACUSTICO
Bottom Movable Sill + polyurethane material for acoustic insulation
Corta viento inferior ajustable + esponja de poliuretano para aislamiento acustico

INCONTROSCROCCO AUTOREGISTRANTE
Self Registering latch
Auto-ajuste de cierre

RIVESTIMENTO INTERNO ED ESTERNO LISCIO SP. 6 mm
Finishing flat internal and external panel 6 mm thickness
Tablero liso espesor 6 mm interno y externo

PANNELLO IN POLISTIRENE ALTA DENSITÀ INTERNO
High density Polystyrene internal panel
Tablero de poliestireno de alta densidad interno

PANNELLO IN POLISTIRENE ALTA DENSITÀ INTERNO ED ESTERNO
High density Polystyrene internal and external panel
Tablero de poliestireno de alta densidad interno y externo

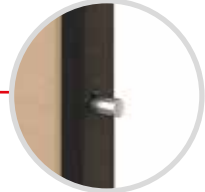

CHIAVISTELLO INFERIORE IN ACCIAIO DIAMETRO 18 mm
Steel bottom bolt 18 mm thickness
Perno inferior de acero de diametro 18 mm

VERSIONI

Versions

Versiones

Silver R



DOPPIA MAPPA NON RICIFRABILE
(CAMBIO FACILE CISA)

Non recordable Double bit

Cerradura doble mapa
sin recodificaciòn

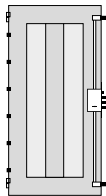

Silver RS



GRUPPO DI CHIUSURA DI SICUREZZA
A DOPPIA MAPPA RICIFRABILE

Recordable Double bit

Cerradura doble mapa
con recodificaciòn

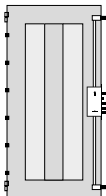

Silver C



CILINDRO EUROPEO

European Cylinder profile

Cerradura con cilindro

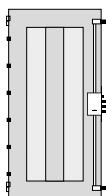

Silver CS



DOPPIO CILINDRO EUROPEO
CON BLOCCO

Double European Cylinder profile
with security lock

Cerradura con doble cilindro
y bloqueo

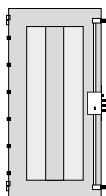

MISURE STANDARD

Standard Measures

Medidas estandar

Larghezza / Width / Anchura:

cm 80 - 85 - 90

Altezza / Height / Altura:

cm 210

FUORI MISURA REALIZZABILI

Possible out of standard

Medidas no estandar que se pueden realizar

Larghezza / Width / Anchura:

da cm 50 a cm 110

from 50 cm to 110 cm

desde 50 cm hasta 110 cm

Altezza / Height / Altura:

da cm 180 a cm 250

from 180 cm to 250 cm

desde 180 cm hasta 250 cm



SISTEMA BREVETTATO

Registered patented system

Sistema patentado

CERNIERA A SCOMPARSA ABSOLUTE

ABSOLUTE invisible hinge

Bisagra invisible ABSOLUTE

MANIGLIERIA DI SERIE

Standard Handles - Manillas estandar

ALLUMINIO BRONZATO

Bronze aluminium
Aluminio bronceado



ARGENTO

Silver
Plateado



OTTONE

Brass
Latòn



MANIGLIERIA OPTIONAL

Optional handles - Manillas opcionales

CROMO SATINATO

Matt chrome
Satinado cromado



FENIX

CROMO SATINATO

Matt chrome
Satinado cromado



CROMO LUCIDO

Bright chrome
Cromado brillante



MANIGLIONI

Fixed handle
Barra fija externa



46 cm 116 cm

DOUBLE

CLASSE 3 di antieffrazione UNI-EN 1627
Anti Burgary - Seguridad contra la efracción

NOVITÀ

TRASMITTANZA TERMICA - 1,5 W/(M².K)
Thermic conduction - Transmitancia termica

ABBATTIMENTO ACUSTICO - 31 dB
Acoustic performance - Aislamiento acustico

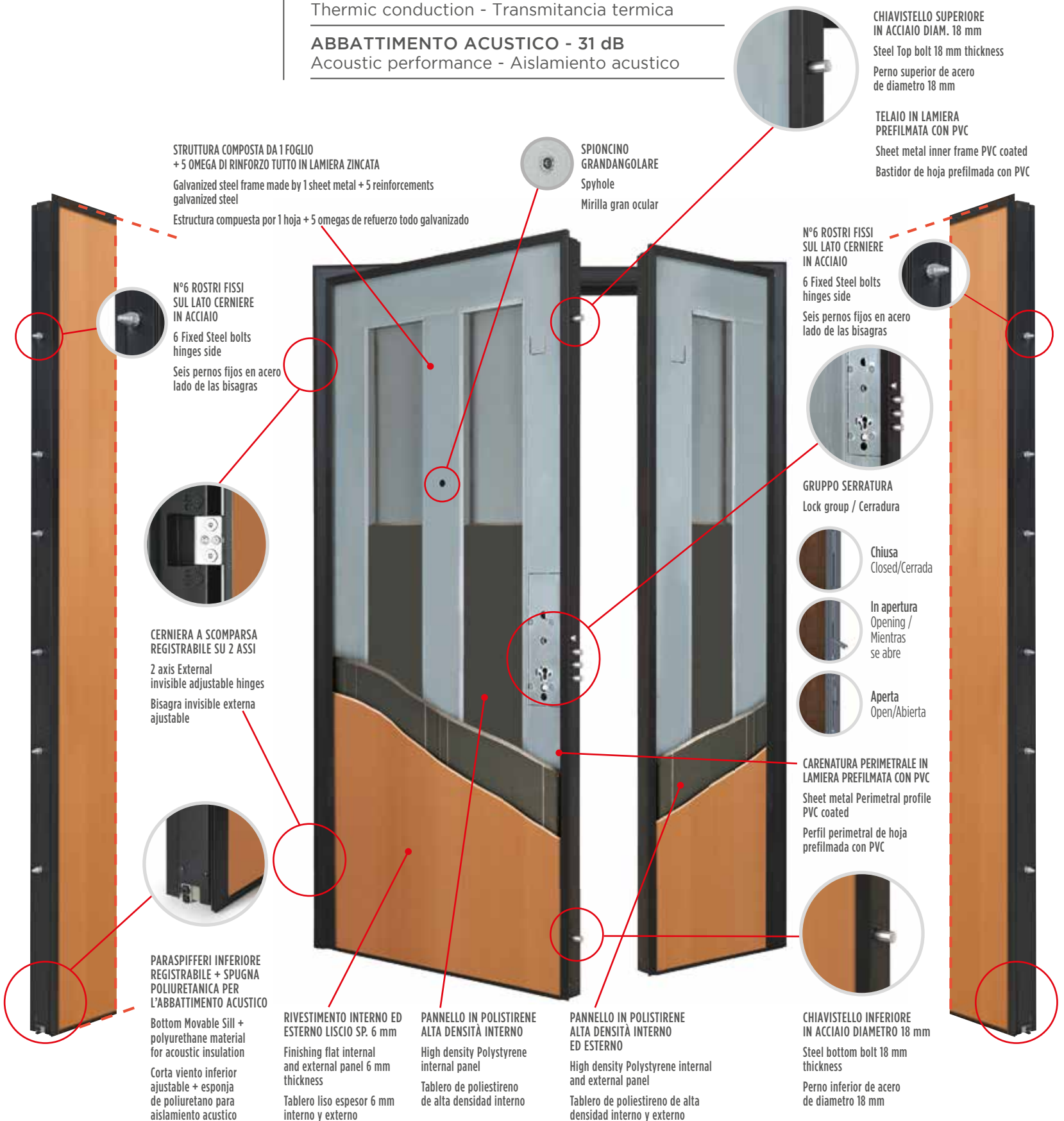

STRUTTURA COMPOSTA DA 1 FOGLIO + 5 OMEGA DI RINFORZO TUTTO IN LAMIERA ZINCATA
Galvanized steel frame made by 1 sheet metal + 5 reinforcements galvanized steel
Estructura compuesta por 1 hoja + 5 omegas de refuerzo todo galvanizado

N°6 ROSTRI FISSI SUL LATO CERNIERE IN ACCIAIO
6 Fixed Steel bolts hinges side
Seis pernos fijos en acero lado de las bisagras

CERNIERA A SCOMPARSA REGISTRABILE SU 2 ASSI
2 axis External invisible adjustable hinges
Bisagra invisible externa ajustable

PARASPIFFERI INFERIORE REGISTRABILE + SPUGNA POLIURETANICA PER L'ABBATTIMENTO ACUSTICO
Bottom Movable Sill + polyurethane material for acoustic insulation
Corta viento inferior ajustable + esponja de poliuretano para aislamiento acustico

RIVESTIMENTO INTERNO ED ESTERNO LISCIO SP. 6 mm
Finishing flat internal and external panel 6 mm thickness
Tablero liso espesor 6 mm interno y externo

PANNELLO IN POLISTIRENE ALTA DENSITÀ INTERNO
High density Polystyrene internal panel
Tablero de poliestireno de alta densidad interno

PANNELLO IN POLISTIRENE ALTA DENSITÀ INTERNO ED ESTERNO
High density Polystyrene internal and external panel
Tablero de poliestireno de alta densidad interno y externo

SPIONCINO GRANDANGOLARE
Spyhole
Mirilla gran ocular

CHIAVISTELLO SUPERIORE IN ACCIAIO DIAM. 18 mm
Steel Top bolt 18 mm thickness
Perno superior de acero de diametro 18 mm

TELAIO IN LAMIERA PREFILMATA CON PVC
Sheet metal inner frame PVC coated
Bastidor de hoja prefilmada con PVC

N°6 ROSTRI FISSI SUL LATO CERNIERE IN ACCIAIO
6 Fixed Steel bolts hinges side
Seis pernos fijos en acero lado de las bisagras

GRUPPO SERRATURA
Lock group / Cerradura

Chiusa
Closed/Cerrada

In apertura
Opening / Mientras se abre

Aperta
Open/Abierta

CARENATURA PERIMETRALE IN LAMIERA PREFILMATA CON PVC
Sheet metal Perimetral profile PVC coated
Perfil perimetral de hoja prefilmada con PVC

CHIAVISTELLO INFERIORE IN ACCIAIO DIAMETRO 18 mm
Steel bottom bolt 18 mm thickness
Perno inferior de acero de diametro 18 mm

VERSIONI

Versions
Versiones

Double R



DOPPIA MAPPA RICIFRABILE
(CAMBIO FACILE CISA)

Recordable Double bit

Cerradura doble mapa
con recodificaciòn

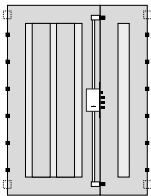

Double C



CILINDRO EUROPEO

European Cylinder profile

Cerradura con cilindro

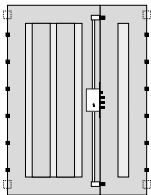

Optional



CILINDRO EUROPEO

+ CILINDRO DI SERVIZIO

European Cylinder profile
+ Service cylinder

Cerradura con cilindro
+ cerradura de servicio

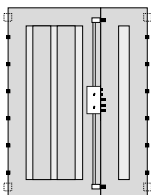

MISURE STANDARD

Standard Measures

Medidas estandar

Larghezza asimmetrica/ Asymmetrical width

Anchura para puerta asimetrica:
cm 80 - 85 - 90 + cm 30 - 35 - 40

Larghezza simmetrica/ Symmetrical width

Anchura para puerta simetrica:
cm 50 - 60 - 65 + cm 50 - 60 - 65

Altezza / Height / Altura:
cm 210

FUORI MISURA REALIZZABILI

Possible out of standard

Medidas no estandar que se pueden realizar

Larghezza / Width / Anchura:

da cm 50 a cm 110

from 50 cm to 110 cm

desde 50 cm hasta 110 cm

Altezza / Height / Altura:

da cm 180 a cm 250

from 180 cm to 250 cm

desde 180 cm hasta 250 cm



SISTEMA BREVETTATO

Registered patented system

Sistema patentado

CERNIERA A SCOMPARSA ABSOLUTE

ABSOLUTE invisible hinge

Bisagra invisible ABSOLUTE

MANIGLIERIA DI SERIE

Standard Handles - Manillas estandar

ALLUMINIO BRONZATO

Bronze aluminium
Aluminio bronceado



ARGENTO

Silver
Plateado



OTTONE

Brass
Latòn



MANIGLIERIA OPTIONAL

Optional handles - Manillas opcionales

CROMO SATINATO

Matt chrome
Satinado cromado



FENIX

CROMO SATINATO

Matt chrome
Satinado cromado



CROMO LUCIDO

Bright chrome
Cromado brillante



MANIGLIONI

Fixed handle
Barra fija externa



46 cm 116 cm

GOLD

CLASSE 3 di antieffrazione UNI-EN 1627
Anti Burglary - Seguridad contra la efracción

TRASMITTANZA TERMICA - 1,3 W/(M².K)
Thermic conduction - Transmitancia termica

ABBATTIMENTO ACUSTICO - 34 dB
Acoustic performance - Aislamiento acustico

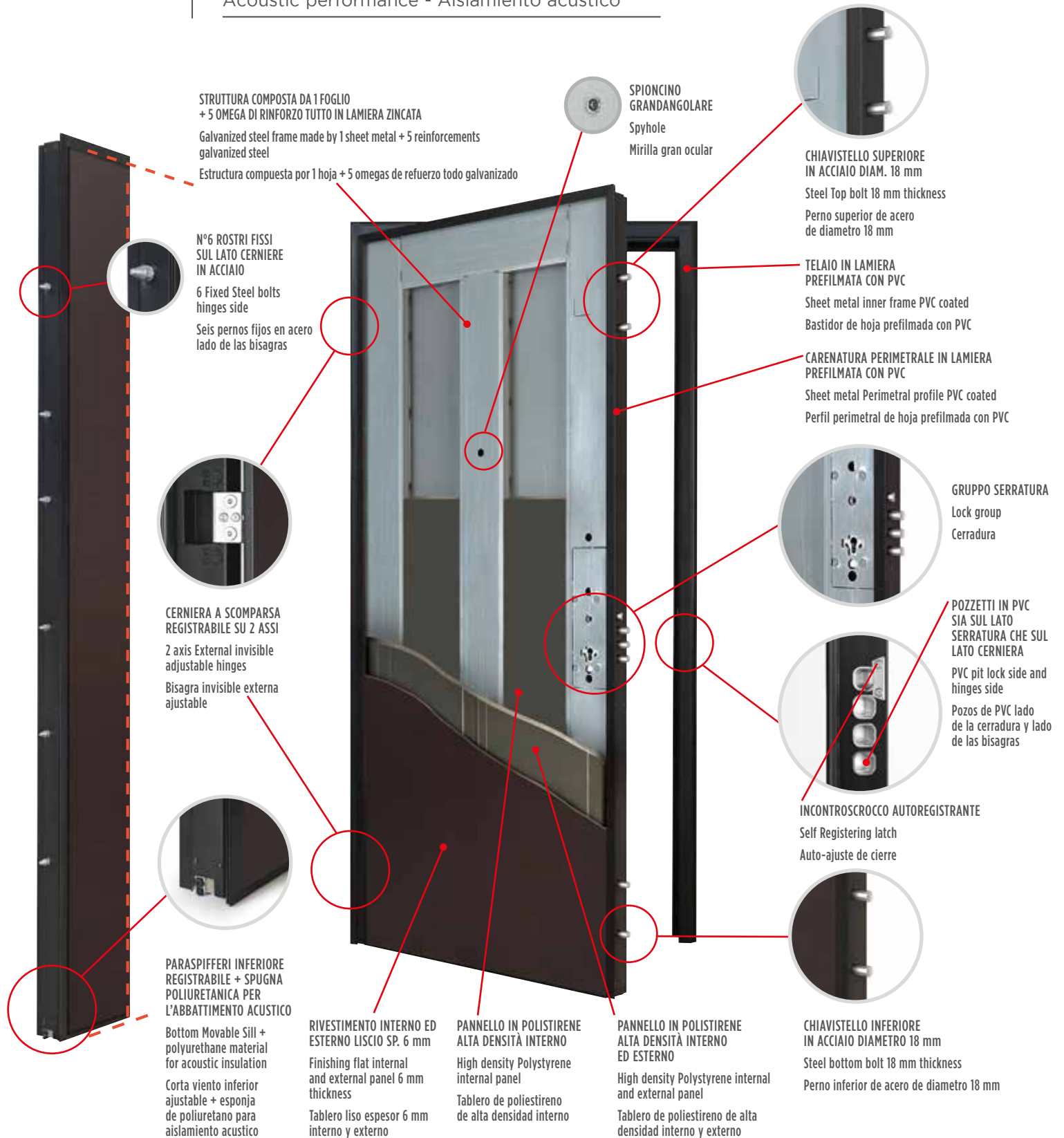

VERSIONI

Versions

Versiones

Gold R



DOPPIA MAPPA NON RICIFRABILE
(CAMBIO FACILE CISA)

Non recordable Double bit

Cerradura doble mapa
sin recodificaciòn

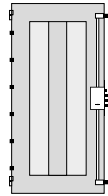

Gold RS



GRUPPO DI CHIUSURA DI SICUREZZA
A DOPPIA MAPPA RICIFRABILE

Recordable Double bit

Cerradura doble mapa
con recodificaciòn

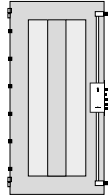

Gold C



CILINDRO EUROPEO

European Cylinder profile

Cerradura con cilindro

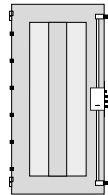

Gold CS



DOPPIO CILINDRO EUROPEO
CON BLOCCO

Double European Cylinder profile
with security lock

Cerradura con doble cilindro
y bloqueo

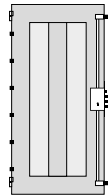

MISURE STANDARD

Standard Measures

Medidas estandar

Larghezza / Width / Anchura:

cm 80 - 85 - 90

Altezza / Height / Altura:

cm 210

FUORI MISURA REALIZZABILI

Possible out of standard

Medidas no estandar que se pueden realizar

Larghezza / Width / Anchura:

da cm 50 a cm 110

from 50 cm to 110 cm

desde 50 cm hasta 110 cm

Altezza / Height / Altura:

da cm 180 a cm 250

from 180 cm to 250 cm

desde 180 cm hasta 250 cm



SISTEMA BREVETTATO

Registered patented system

Sistema patentado

CERNIERA A SCOMPARSATA ABSOLUTE

ABSOLUTE invisible hinge

Bisagra invisible ABSOLUTE

MANIGLIERIA DI SERIE

Standard Handles - Manillas estandar

ALLUMINIO BRONZATO

Bronze aluminium
Aluminio bronceado



ARGENTO

Silver
Plateado



OTTONE

Brass
Latòn



MANIGLIERIA OPTIONAL

Optional handles - Manillas opcionales

CROMO SATINATO

Matt chrome
Satinado cromado



FENIX

CROMO SATINATO

Matt chrome
Satinado cromado



CROMO LUCIDO

Bright chrome
Cromado brillante



MANIGLIONI

Fixed handle
Barra fija externa



46 cm 116 cm

PLATINUM

CLASSE 4 di antieffrazione UNI-EN 1627
Anti Burglary - Seguridad contra la efracción

TRASMITTANZA TERMICA - 1,8 W/(M².K)
Thermic conduction - Transmitancia termica

ABBATTIMENTO ACUSTICO - 34 dB
Acoustic performance - Aislamiento acustico

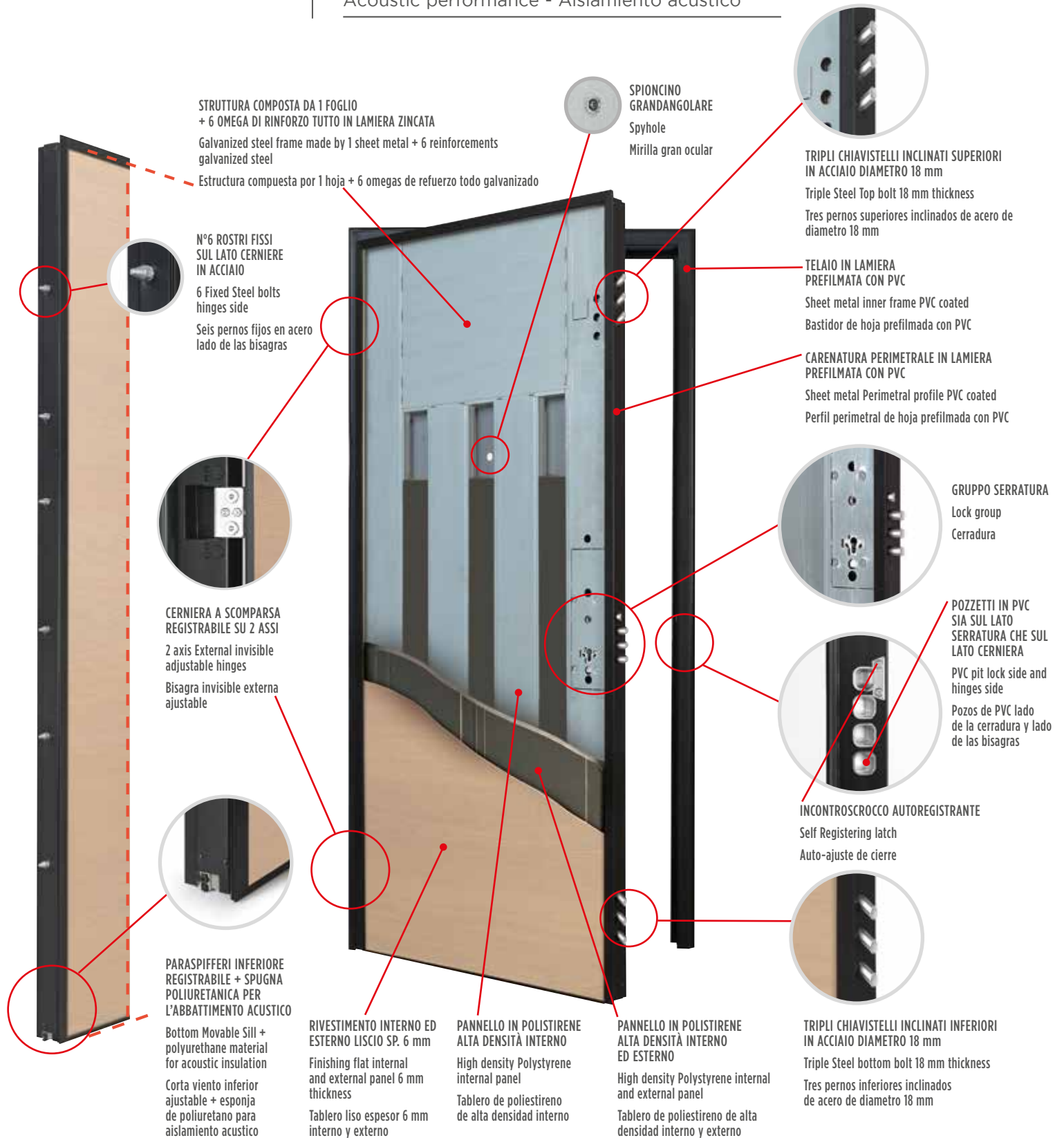

STRUTTURA COMPOSTA DA 1 FOGLIO + 6 OMEGA DI RINFORZO TUTTO IN LAMIERA ZINCATO
Galvanized steel frame made by 1 sheet metal + 6 reinforcements galvanized steel
Estructura compuesta por 1 hoja + 6 omegas de refuerzo todo galvanizado

N°6 ROSTRI FISSI SUL LATO CERNIERE IN ACCIAIO
6 Fixed Steel bolts hinges side
Seis pernos fijos en acero lado de las bisagras

CERNIERA A SCOMPARSA REGISTRABILE SU 2 ASSI
2 axis External invisible adjustable hinges
Bisagra invisible esterna ajustable

PARASPIFFERI INFERIORE REGISTRABILE + SPUGNA POLIURETANICA PER L'ABBATTIMENTO ACUSTICO
Bottom Movable Sill + polyurethane material for acoustic insulation
Corta viento inferior ajustable + esponja de poliuretano para aislamiento acustico

RIVESTIMENTO INTERNO ED ESTERNO LISCIO SP. 6 mm
Finishing flat internal and external panel 6 mm thickness
Tablero liso espesor 6 mm interno y externo

PANNELLO IN POLISTIRENE ALTA DENSITÀ INTERNO
High density Polystyrene internal panel
Tablero de poliestireno de alta densidad interno

PANNELLO IN POLISTIRENE ALTA DENSITÀ INTERNO ED ESTERNO
High density Polystyrene internal and external panel
Tablero de poliestireno de alta densidad interno y externo

SPIONCINO GRANDANGOLARE
Spyhole
Mirilla gran ocular

TRIPLI CHIAVISTELLI INCLINATI SUPERIORI IN ACCIAIO DIAMETRO 18 mm
Triple Steel Top bolt 18 mm thickness
Tres pernos superiores inclinados de acero de diametro 18 mm

TELAIO IN LAMIERA PREFILMATA CON PVC
Sheet metal inner frame PVC coated
Bastidor de hoja prefilmada con PVC

CARENATURA PERIMETRALE IN LAMIERA PREFILMATA CON PVC
Sheet metal Perimetral profile PVC coated
Perfil perimetral de hoja prefilmada con PVC

GRUPPO SERRATURA
Lock group
Cerradura

POZZETTI IN PVC SIA SUL LATO SERRATURA CHE SUL LATO CERNIERA
PVC pit lock side and hinges side
Pozos de PVC lado de la cerradura y lado de las bisagras

INCONTROSCROCCO AUTOREGISTRANTE
Self Registering latch
Auto-ajuste de cierre

TRIPLI CHIAVISTELLI INCLINATI INFERIORI IN ACCIAIO DIAMETRO 18 mm
Triple Steel bottom bolt 18 mm thickness
Tres pernos inferiores inclinados de acero de diametro 18 mm

VERSIONI

Versions
Versiones

Platinum C



CILINDRO EUROPEO
European Cylinder profile
Cerradura con cilindro

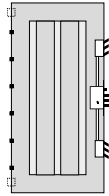

Platinum CS



DOPPIO CILINDRO EUROPEO
CON BLOCCO
Double European Cylinder profile
with security lock
Cerradura con doble cilindro
y bloqueo

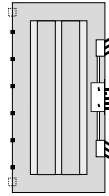

MISURE STANDARD

Standard Measures
Medidas estandar

Larghezza / Width / Anchura:
cm 80 - 85 - 90

Altezza / Height / Altura:
cm 210

FUORI MISURA REALIZZABILI

Possible out of standard

Medidas no estandar que se pueden realizar

Larghezza / Width / Anchura:
da cm 50 a cm 110
from 50 cm to 110 cm
desde 50 cm hasta 110 cm

Altezza / Height / Altura:
da cm 180 a cm 250
from 180 cm to 250 cm
desde 180 cm hasta 250 cm



SISTEMA BREVETTATO

Registered patented system
Sistema patentado

CERNIERA A SCOMPARSA ABSOLUTE
ABSOLUTE invisible hinge
Bisagra invisible ABSOLUTE

MANIGLIERIA DI SERIE

Standard Handles - Manillas estandar

ALLUMINIO BRONZATO
Bronze aluminium
Aluminio bronceado



ARGENTO
Silver
Plateado



OTTONE
Brass
Latón



MANIGLIERIA OPTIONAL

Optional handles - Manillas opcionales

CROMO SATINATO
Matt chrome
Satinado cromado



FENIX

CROMO SATINATO
Matt chrome
Satinado cromado



CROMO LUCIDO
Bright chrome
Cromado brillante



MANIGLIONI
Fixed handle
Barra fija externa



46 cm 116 cm

TITANIUM

CLASSE 4 di anti-effrazione UNI-EN 1627
Anti Burglary - Seguridad contra la efracción

TRASMITTANZA TERMICA - 1,8 W/(M².K)
Thermic conduction - Transmitancia termica

ABBATTIMENTO ACUSTICO - 34 dB
Acoustic performance - Aislamiento acustico

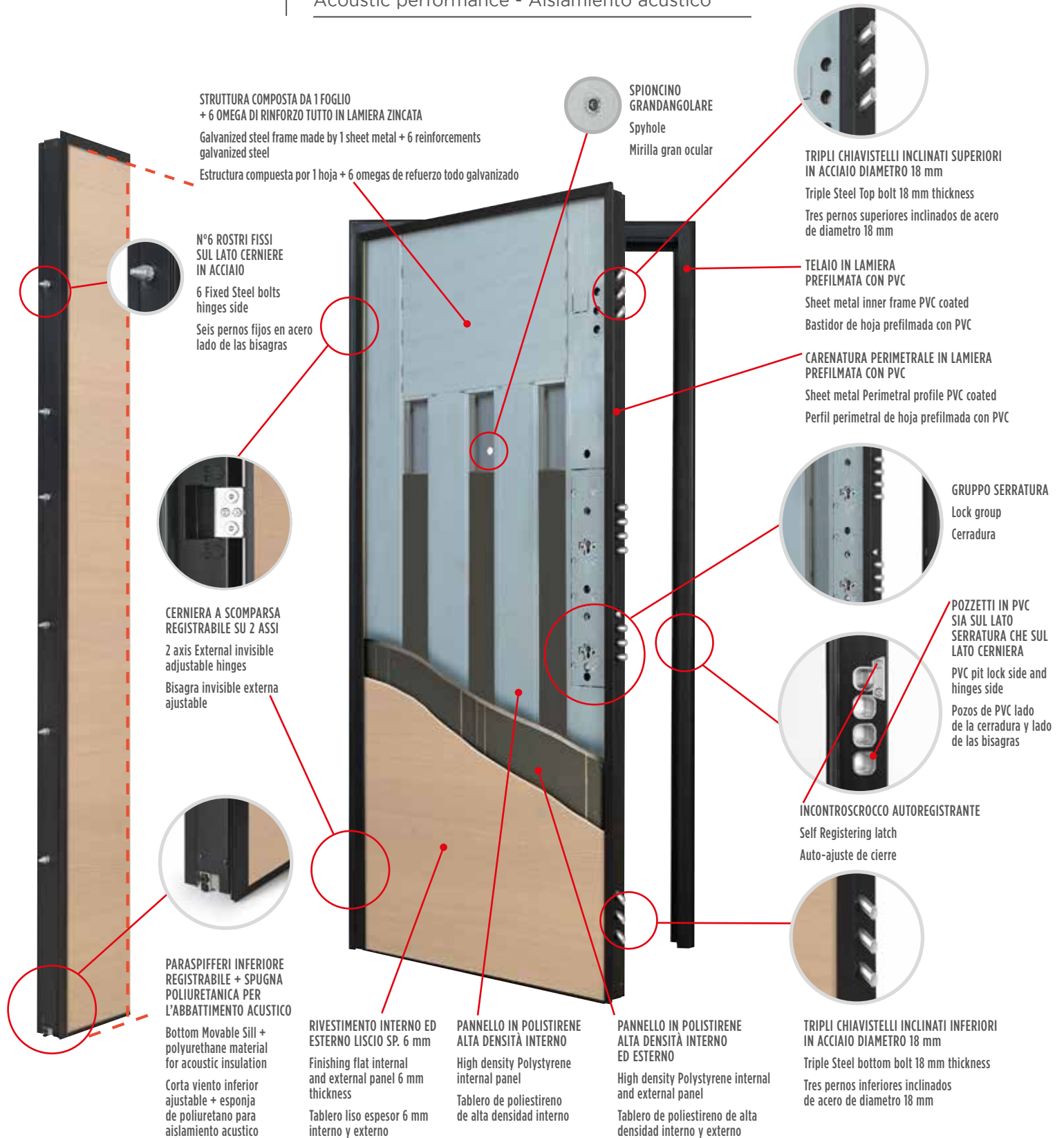

STRUTTURA COMPOSTA DA 1 FOGLIO + 6 OMEGA DI RINFORZO TUTTO IN LAMIERA ZINCATA
Galvanized steel frame made by 1 sheet metal + 6 reinforcements galvanized steel
Estructura compuesta por 1 hoja + 6 omegas de refuerzo todo galvanizado

N°6 ROSTRI FISSI SUL LATO CERNIERE IN ACCIAIO
6 Fixed Steel bolts hinges side
Seis pernos fijos en acero lado de las bisagras

CERNIERA A SCOMPARSA REGISTRABILE SU 2 ASSI
2 axis External invisible adjustable hinges
Bisagra invisible externa ajustable

PARASPIFFERI INFERIORE REGISTRABILE + SPUGNA POLIURETANICA PER L'ABBATTIMENTO ACUSTICO
Bottom Movable Sill + polyurethane material for acoustic insulation
Corta viento inferior ajustable + esponja de poliuretano para aislamiento acustico

RIVESTIMENTO INTERNO ED ESTERNO LISCIO SP. 6 mm
Finishing flat internal and external panel 6 mm thickness
Tablero liso espesor 6 mm interno y externo

PANNELLO IN POLISTIRENE ALTA DENSITÀ INTERNO
High density Polystyrene internal panel
Tablero de poliestireno de alta densidad interno

PANNELLO IN POLISTIRENE ALTA DENSITÀ INTERNO ED ESTERNO
High density Polystyrene internal and external panel
Tablero de poliestireno de alta densidad interno y externo

SPIONCINO GRANDANGOLARE
Spyhole
Mirilla gran ocular

TRIPLI CHIAVISTELLI INCLINATI SUPERIORI IN ACCIAIO DIAMETRO 18 mm
Triple Steel Top bolt 18 mm thickness
Tres pernos superiores inclinados de acero de diametro 18 mm

TELAIO IN LAMIERA PREFILMATA CON PVC
Sheet metal inner frame PVC coated
Bastidor de hoja prefilmada con PVC

CARENATURA PERIMETRALE IN LAMIERA PREFILMATA CON PVC
Sheet metal Perimetral profile PVC coated
Perfil perimetral de hoja prefilmada con PVC

GRUPPO SERRATURA
Lock group
Cerradura

POZZETTI IN PVC SIA SUL LATO SERRATURA CHE SUL LATO CERNIERA
PVC pit lock side and hinges side
Pozos de PVC lado de la cerradura y lado de las bisagras

INCONTROSCROCCO AUTOREGISTRANTE
Self Registering latch
Auto-ajuste de cierre

TRIPLI CHIAVISTELLI INCLINATI INFERIORI IN ACCIAIO DIAMETRO 18 mm
Triple Steel bottom bolt 18 mm thickness
Tres pernos inferiores inclinados de acero de diametro 18 mm

VERSIONI

Versions
Versiones

Titanium CS



DOPPIO CILINDRO EUROPEO
CON BLOCCO

Double European Cylinder profile
with security lock

Cerradura con doble cilindro
y bloqueo

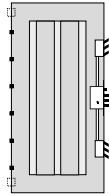

MISURE STANDARD

Standard Measures
Medidas estandar

Larghezza / Width / Anchura:
cm 80 - 85 - 90

Altezza / Height / Altura:
cm 210

FUORI MISURA REALIZZABILI

Possible out of standard

Medidas no estandar que se pueden realizar

Larghezza / Width / Anchura:
da cm 50 a cm 110

from 50 cm to 110 cm

desde 50 cm hasta 110 cm

Altezza / Height / Altura:

da cm 180 a cm 250

from 180 cm to 250 cm

desde 180 cm hasta 250 cm



SISTEMA BREVETTATO

Registered patented system

Sistema patentado

CERNIERA A SCOMPARSA ABSOLUTE

ABSOLUTE invisible hinge

Bisagra invisible ABSOLUTE

MANIGLIERIA DI SERIE

Standard Handles - Manillas estandar

ALLUMINIO BRONZATO

Bronze aluminium
Aluminio bronceado



ARGENTO

Silver
Plateado



OTTONE

Brass
Latón



MANIGLIERIA OPTIONAL

Optional handles - Manillas opcionales

CROMO SATINATO

Matt chrome
Satinado cromado



FENIX

CROMO SATINATO

Matt chrome
Satinado cromado



CROMO LUCIDO

Bright chrome
Cromado brillante



MANIGLIONI

Fixed handle
Barra fija externa



46 cm 116 cm

CLASSE 3 di antieffrazione UNI-EN 1627
Anti Burglary - Seguridad contra la efracción

TRASMITTANZA TERMICA - 1,4 W/(M².K)
Thermic conduction - Transmitancia termica

ABBATTIMENTO ACUSTICO - 34 dB
Acoustic performance - Aislamiento acustico

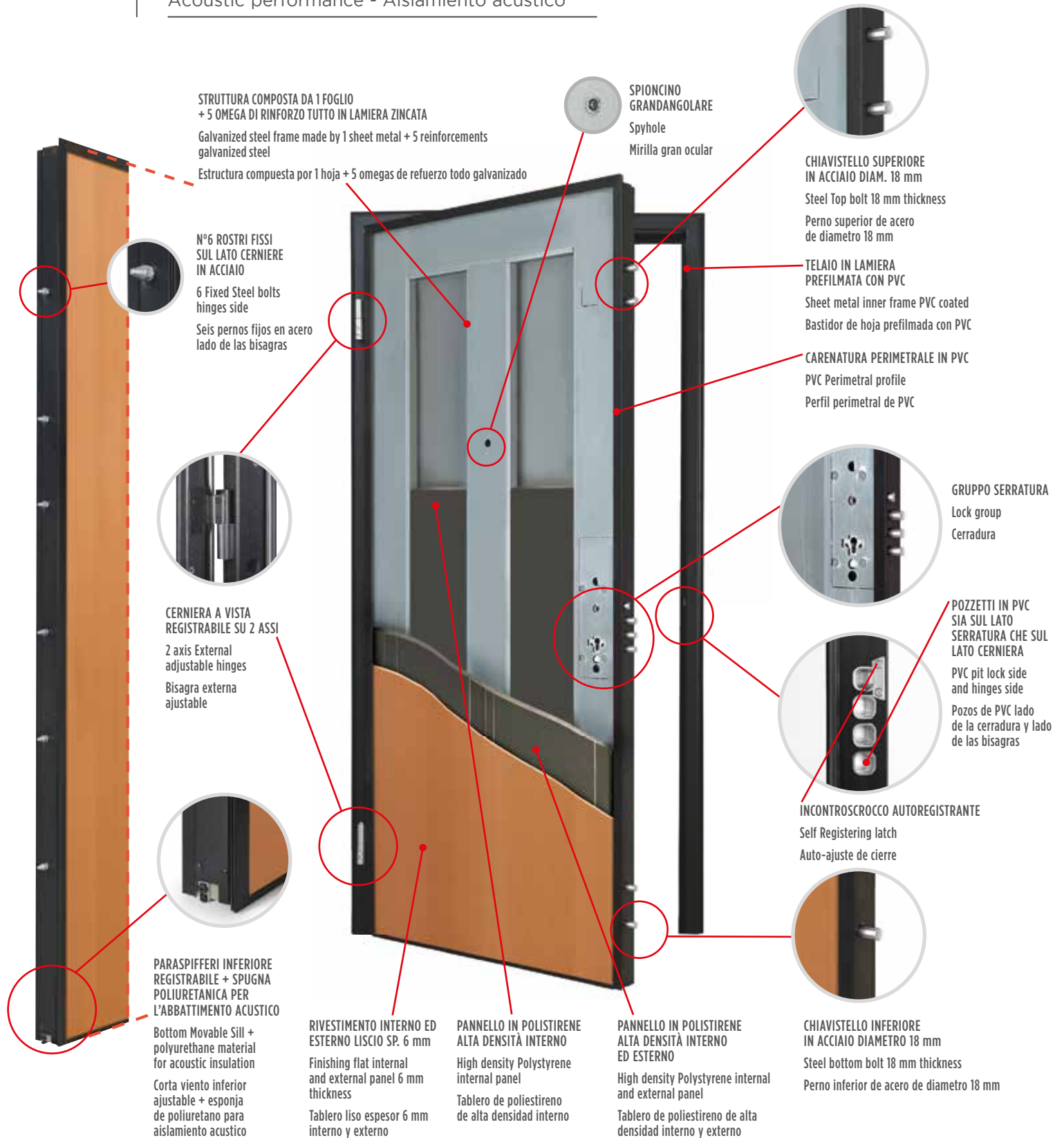

VERSIONI

Versions

Versiones

ZTL C



CILINDRO EUROPEO
European Cylinder profile
Cerradura con cilindro

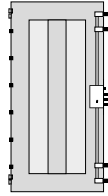

ZTL CS



DOPPIO CILINDRO EUROPEO
CON BLOCCO
Double European Cylinder profile
with security lock
Cerradura con doble cilindro
y bloqueo

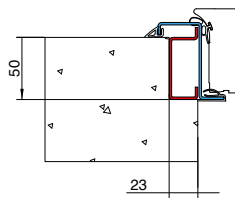
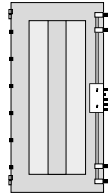

MONTAGGIO STANDARD
Standard set up
Montaje estándar

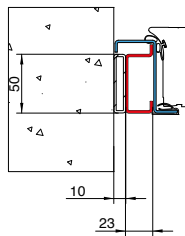

MONTAGGIO IN LUCE
Out side wall set up
Montaje sin premarco

MISURE STANDARD

Standard Measures

Medidas estandar

Larghezza / Width / Anchura:
cm 80 - 85 - 90

Altezza / Height / Altura:
cm 210

FUORI MISURA REALIZZABILI

Possible out of standard

Medidas no estandar que se pueden realizar

Larghezza / Width / Anchura:
da cm 50 a cm 110
from 50 cm to 110 cm
desde 50 cm hasta 110 cm

Altezza / Height / Altura:
da cm 180 a cm 250
from 180 cm to 250 cm
desde 180 cm hasta 250 cm

MANIGLIERIA DI SERIE

Standard Handles - Manillas estandar

ALLUMINIO BRONZATO

Bronze aluminium
Aluminio bronceado



ARGENTO

Silver
Plateado



OTTONE

Brass
Latón



MANIGLIERIA OPTIONAL

Optional handles - Manillas opcionales

CROMO SATINATO

Matt chrome
Satinado cromado



FENIX

CROMO SATINATO

Matt chrome
Satinado cromado



CROMO LUCIDO

Bright chrome
Cromado brillante



MANIGLIONI

Fixed handle
Barra fija externa



46 cm 116 cm

MAGMA 30

OMOLOGATA TAGLIA FUOCO EI2-30 secondo la norma EN 1634-1 - Certified Fireproof EI2-30 - A prueba de fuego EI2-30

TRASMITTANZA TERMICA - 2,0 W/(M².K)
Thermic conduction - Transmitancia termica

ABBATTIMENTO ACUSTICO - 35 dB
Acoustic performance - Aislamiento acustico

Magma 30

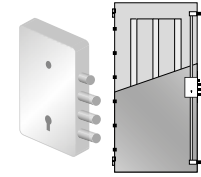

CILINDRO EUROPEO
European Cylinder profile
Cerradura con cilindro y bloqueo

STRUTTURA COMPOSTA DA 1 FOGLIO + 6 OMEGA DI RINFORZO TUTTO IN LAMIERA ZINCATA
Galvanized steel frame made by 1 sheet metal + 6 reinforcements
Estructura compuesta por 1 hoja + 6 omegas de refuerzo todo galvanizado

LANA DI ROCCIA
Rock wool - Lana de roca

N°6 ROSTRI FISSI SUL LATO CERNIERE IN ACCIAIO
6 Fixed Steel bolts hinges side

Seis pernos fijos en acero lado de las bisagras



CERNIERA A VISTA REGISTRABILE SU 2 ASSI
2 axis External adjustable hinges
Bisagra externa ajustable



PARASPIFFERI INFERIORE REGISTRABILE + SPUGNA POLIURETANICA PER L'ABBATTIMENTO ACUSTICO
Bottom Movable Sill + polyurethane material for acoustic insulation
Corta viento inferior ajustable + esponja de poliuretano para aislamiento acustico

RIVESTIMENTO INTERNO ED ESTERNO LISCIO SP. 6 mm
Finishing flat internal and external panel 6 mm thickness
Tablero liso espesor 6 mm interno y externo

MATERIALE CERAMICO
Ceramic material
Material ceramico

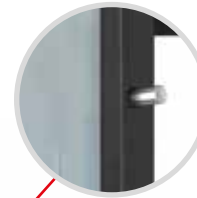

CHIAVISTELLO SUPERIORE IN ACCIAIO DIAM. 18 mm
Steel Top 18 mm thickness
Perno superior de acero de diametro 18 mm

TELAIO IN LAMIERA PREFILMATA CON PVC
Sheet metal inner frame PVC coated
Bastidor de hoja prefilmada con PVC

CARENATURA PERIMETRALE IN LAMIERA PREFILMATA CON PVC
Sheet metal Perimetral profile PVC coated
Perfil perimetral de hoja prefilmada con PVC



GRUPPO SERRATURA
Lock group
Cerradura

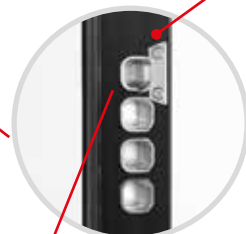

POZZETTI IN PVC SIA SUL LATO SERRATURA CHE SUL LATO CERNIERA
PVC pit lock side and hinges side
Pozos de PVC lado de la cerradura y lado de las bisagras

INCONTROSCROCCO AUTOREGISTRANTE
Self Registering latch
Auto-ajuste de cierre

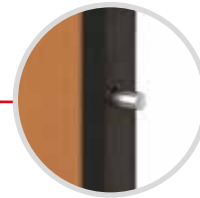

CHIAVISTELLO INFERIORE IN ACCIAIO DIAMETRO 18 mm
Steel bottom bolt 18 mm thickness
Perno inferior de acero de diametro 18 mm

MAGMA 60

OMOLOGATA TAGLIA FUOCO REI 60 secondo la norma EN 1634-1
Certified Fireproof REI 60 - A prueba de fuego REI 60

TRASMITTANZA TERMICA - 2,2 W/(M².K)
Thermic conduction - Transmitancia termica

ABBATTIMENTO ACUSTICO - 34 dB
Acoustic performance - Aislamiento acustico

Magma 60

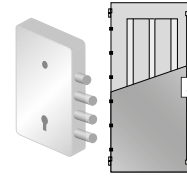

CILINDRO EUROPEO
European Cylinder profile
Cerradura con cilindro y bloqueo

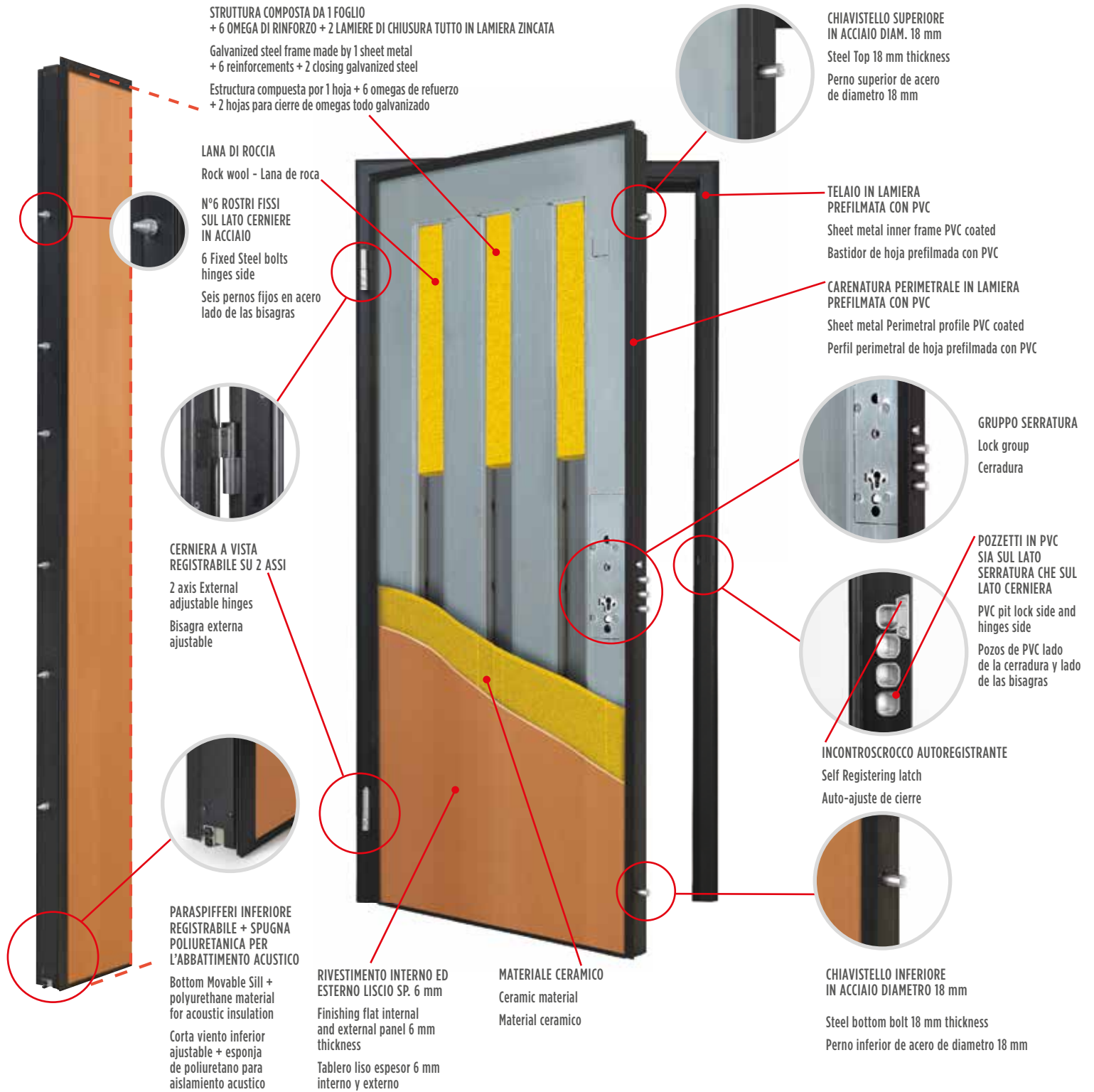

MAGMA 90

OMOLOGATA TAGLIA FUOCO EI2-90 EI1-60
secondo la norma EN 1634-1 - Certified Fireproof
EI2-90 EI1-60 - A prueba de fuego EI2-90 EI1-60

TRASMITTANZA TERMICA - 1,8 W/(M².K)
Thermic conduction - Transmitancia termica

ABBATTIMENTO ACUSTICO - 35DB / 42DB
Acoustic performance - Aislamiento acustico

Magma 90

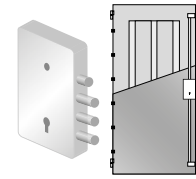

CILINDRO EUROPEO
European
Cylinder profile
Cerradura
con cilindro
y bloqueo

**STRUTTURA COMPOSTA DA 1 FOGLIO
+ 6 OMEGA DI RINFORZO + 2 LAMIERE DI CHIUSURA TUTTO IN LAMIERA ZINCATA**

Galvanized steel frame made by 1 sheet metal
+ 6 reinforcements + 2 closing galvanized steel

Estructura compuesta por 1 hoja + 6 omegas de refuerzo
+ 2 hojas para cierre de omegas todo galvanizado

LANA DI ROCCIA
Rock wool - Lana de roca

**N°6 ROSTRI FISSI
SUL LATO CERNIERE
IN ACCIAIO**

6 Fixed Steel bolts
hinges side

Seis pernos fijos en acero
lado de las bisagras

**CERNIERA A VISTA
REGISTRABILE SU 3 ASSI**

3 axis External
adjustable hinges

Bisagra esterna
ajustable

**PARASPIFFERI INFERIORE
REGISTRABILE + SPUGNA
POLIURETANICA PER
L'ABBATTIMENTO ACUSTICO**

Bottom Movable Sill +
polyurethane material
for acoustic insulation

Corta viento inferior
ajustable + esponja
de poliuretano para
aislamiento acustico

**RIVESTIMENTO INTERNO ED
ESTERNO LISCIO SP. 6 mm**

Finishing flat internal
and external panel 6 mm
thickness

Tablero liso espesor 6 mm
interno y externo

MATERIALE CERAMICO

Ceramic material
Material ceramico

**CHIAVISTELLO SUPERIORE
IN ACCIAIO DIAM. 18 mm**

Steel Top 18 mm thickness

Perno superior de acero
de diametro 18 mm

**TELAIO IN LAMIERA
PREFILMATA CON PVC**

Sheet metal inner frame
PVC coated

Bastidor de hoja prefilmada con
PVC

**CARENATURA PERIMETRALE IN LAMIERA
PREFILMATA CON PVC**

Sheet metal Perimetral profile
PVC coated

Perfil perimetral de hoja prefilmada con
PVC

GRUPPO SERRATURA

Lock group

Cerradura

**POZZETTI IN PVC
SIA SUL LATO
SERRATURA CHE SUL
LATO CERNIERA**

PVC pit lock side and
hinges side

Pozos de PVC lado
de la cerradura y lado
de las bisagras

INCONTROSCROCCO AUTOREGISTRANTE

Self Registering latch

Auto-ajuste de cierre

**CHIAVISTELLO INFERIORE
IN ACCIAIO DIAMETRO 18 mm**

Steel bottom bolt 18 mm thickness

Perno inferior de acero de diametro 18 mm

VERSIONI

Versions

Versiones

PUÒ MONTARE LA SERRATURA MOTORIZZATA CON O SENZA FUNZIONE ANTIPANICO
PUÒ MONTARE LA SERRATURA ELETTRICA (SOLO SCROCCO MOVIMENTATO)

It can install motorized lock (with or without panic lock)

It can install electric lock (only with moved latch)

Posible instalacion de cerradura motorizada con o sin funcion anti-panico

Posible instalacion de cerradura electrica (solo estafa movil)

MISURE STANDARD

VALIDE PER I MODELLI MAGMA 30-60-90

Standard Measures

Medidas estandar

Larghezza / Width / Anchura:

cm 80 - 85 - 90

Altezza / Height / Altura:

cm 210

FUORI MISURA REALIZZABILI

VALIDE PER I MODELLI MAGMA 30-60-90

Possible out of standard

Medidas no estandar que se pueden realizar

Larghezza / Width / Anchura:

da cm 80 a cm 103

from 80 cm to 103 cm

desde 80 cm hasta 103 cm

Altezza / Height / Altura

da cm 190 a cm 230

from 190 cm to 230 cm

desde 190 cm hasta 230 cm

Area fino a / Area up to / àrea hasta: 2.16 m²

MANIGLIERIA DI SERIE

Standard Handles - Manillas estandar

ALLUMINIO BRONZATO

Bronze aluminium
Aluminio bronceado



ARGENTO

Silver
Plateado



OTTONE

Brass
Latón



MANIGLIERIA OPTIONAL

Optional handles - Manillas opcionales

CROMO SATINATO

Matt chrome
Satinado cromado

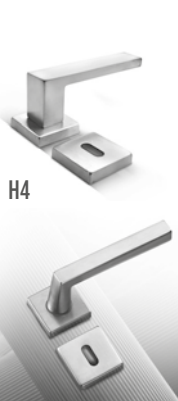

FENIX

CROMO SATINATO

Matt chrome
Satinado cromado



CROMO LUCIDO

Bright chrome
Cromado brillante



MANIGLIONI

Fixed handle
Barra fija externa



46 cm 116 cm



OPTIONALS

ZTL CLASSE 3 - 1.4 W/(m²K)

UN PRODOTTO CHE NASCE PER SODDISFARE UN BISOGNO NELL'AMBITO DELLA RISTRUTTURAZIONE, SPESSO NEI CENTRI STORICI, DOVE GLI INGOMBRI SONO MINIMI ED E' NECESSARIO SOSTITUIRE LA PORTA ESISTENTE CON UN INTERVENTO POCO INVASIVO.

A product thought to satisfy the need in renovation, often in old towns, to reduce dimensions and avoid invasive intervention, in order to replace the existing door.

Un producto que nace para satisfacer las exigencias en caso de renovacion que se encuentran sobre todo en el centro urbano, donde los espacios son minimos y se necesita remplazar la puerta existente con una intervencion poco invasiva.

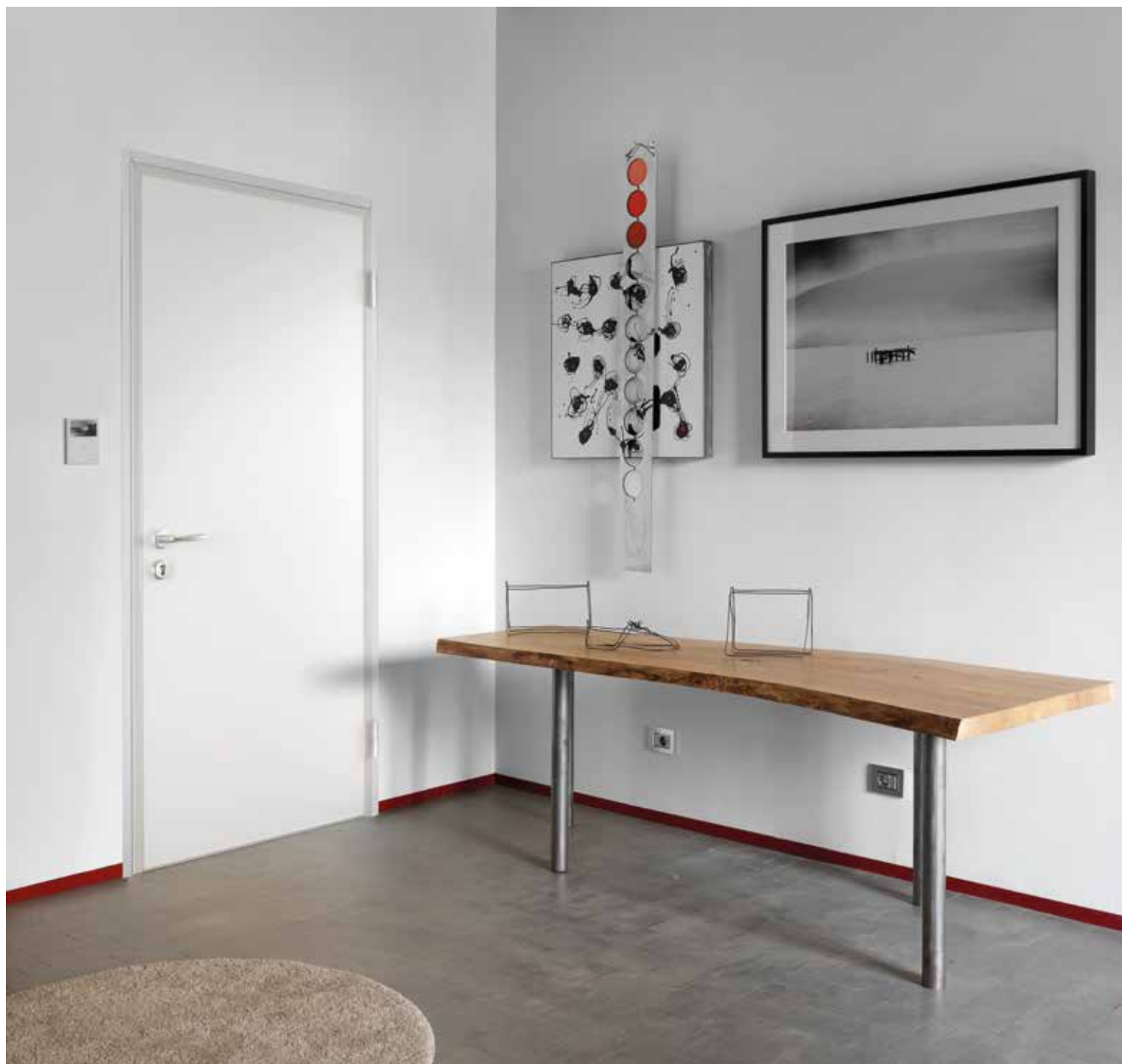



GRAZIE AD UNA SPECIALE CERNIERA DOTATA DI GRANO DI REGOLAZIONE ORIZZONTALE È POSSIBILE REGISTRARE L'ANTA ANCHE IN PROFONDITÀ OLTRE CHE IN ALTEZZA E LARGHEZZA.

Thanks to a special hinge provided with a specific screw for horizontal adjustment (M8?), it is possible to register the door not only in height and in width, but also in depth.

Gracias a una bisagra especial que se puede ajustar en horizontal es posible arreglar la hoja tambien en profundidad, altura y ancho .

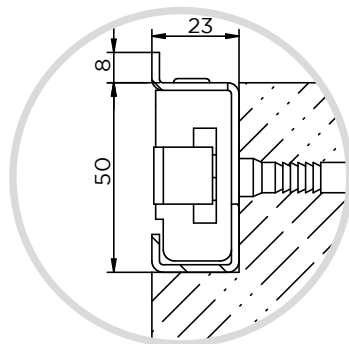

SISTEMA DI FISSAGGIO TRADIZIONALE CON LA MURATURA DEL CONTROTELAIO
Traditional fixing system with walled subframe
Sistema de fijacion tradicional con montaje del premarco

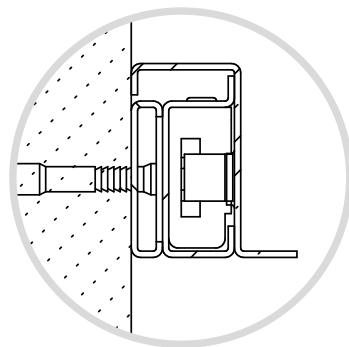

SISTEMA DI FISSAGGIO DEL TELAIO ACCOPPIATO AL CONTROTELAIO TRAMITE TASSELLO CHIMICO
Fixing system with the frame coupled to the subframe by chemical screw anchor
Sistema de fijacion del bastidor al premarco con anclaje quimico



IN AMBITO DI RISTRUTTURAZIONE PUÒ ESSERE IMPORTANTE RIVESTIRE ESTERNAMENTE LA PORTA ZTL CON PANNELLI IN LEGNO DELLA LINEA PRIMA CLASSE OPPURE DELLA LINEA URBAN CHE RICALCA PERFETTAMENTE LE GEOMETRIE DELLA PORTA SOSTITUITA PER UN INTERVENTO RISPETTOSO DEGLI ELEMENTI ESTETICI ESISTENTI.

In the field of restoration it could be useful to cover the ZTL door externally with Primaclasse or Urban collection wood panels, which perfectly reproduce the structure of the replaced door in order to operate in respect of the aesthetic elements already existing.

Hablando de renovacion podria ser importante poner en el lado externo de la puerta ztl los tableros de la linea "primaclasse" o "urban" que reproducen los dibujos de la puerta vieja, eso para una intervencion que respecta los elementos esteticos ya presentes

DOPPIO BATTENTE

DUO (cerniera a vista)

DOUBLE (cerniera a scomparsa)

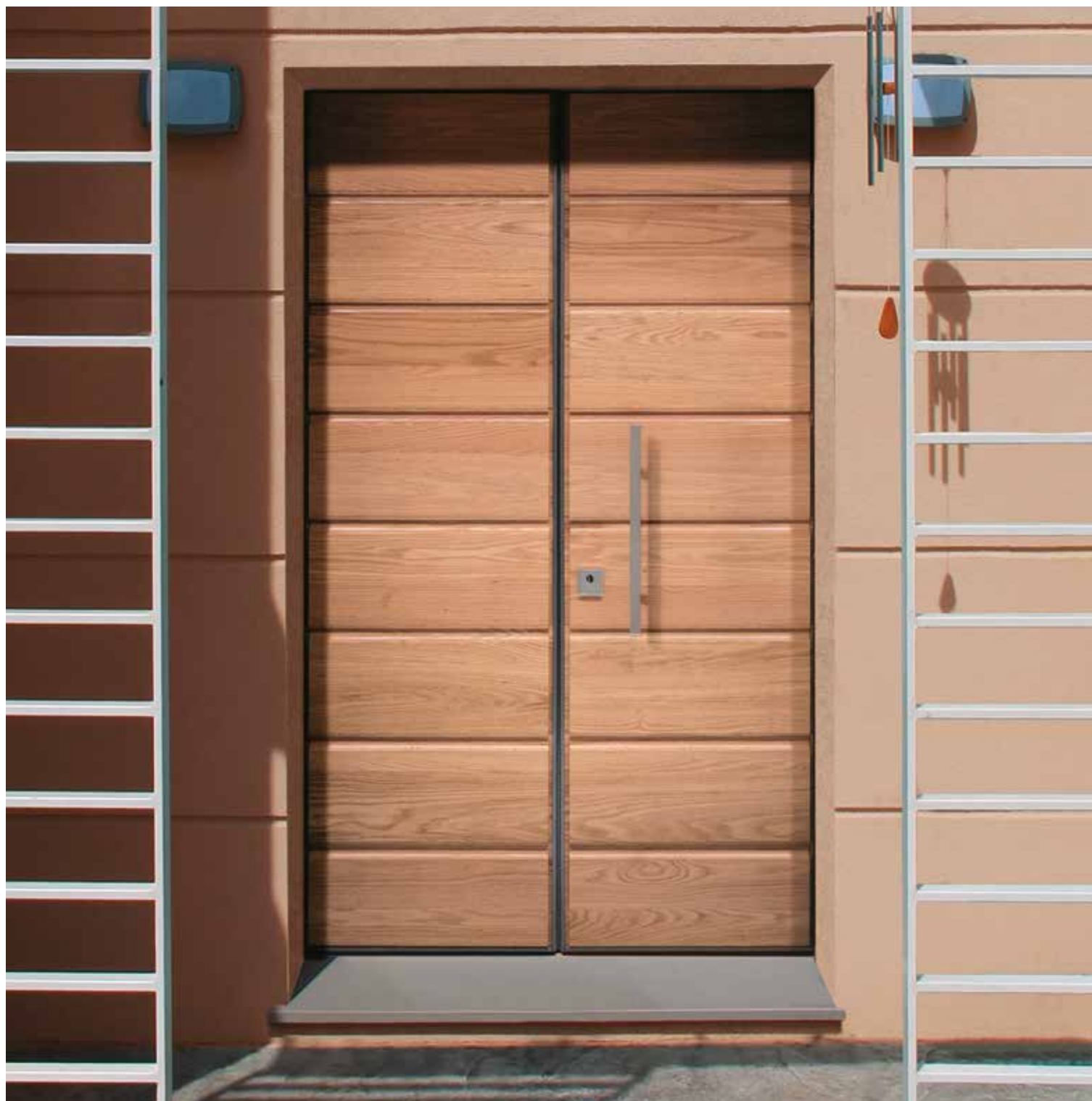



SOLUZIONI DI RIVESTIMENTO INTERNO

Available solutions for internal panels

Soluciones de tableros internos



PANNELLO INTERNO DA 6 MM A INCASSO DELLA CARENATURA

6 mm internal panel mounted inside leaf profile

Tablero interno de 6mm dentro del marco



PANNELLO INTERNO AVVOLGENTE A COPERTURA DELLA CARENATURA REALIZZABILE CON QUALSIASI RIVESTIMENTO DA 15 MM.

Internal panel that envelops and covers leaf profile, available with all 15mm thickness panels

Tablero interno que cubre el marco posible con cualquier tablero de 15mm

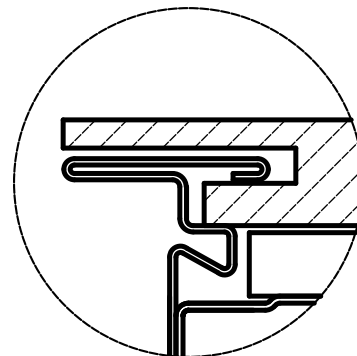

LEVA PER PORTA A 2 ANTE

Lever for 2 leaves door

Palanca para puerta 2 hojas



CHIUSA
Closed
Cerrada



IN APERTURA
Opening
Mientras se abre

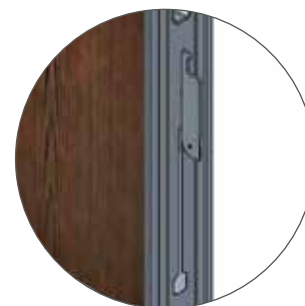

APERTA
Open
Abierta

FINISTRATURA

Glazing/Cristales

Per tutti i modelli esclusi/For all models except

Para todos los modelos excluidos:

Magma 30, Magma 60, Magma 90



VETROCAMERA STANDARD PER ANTE FINESTRATE/ SOPRALUCE/FISSI VETRATI

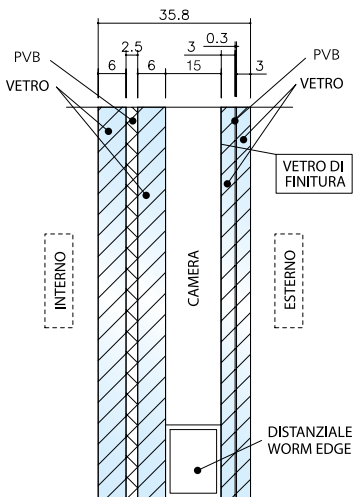

VETROCAMERA IN OPZIONE PER ANTE FINESTRATE

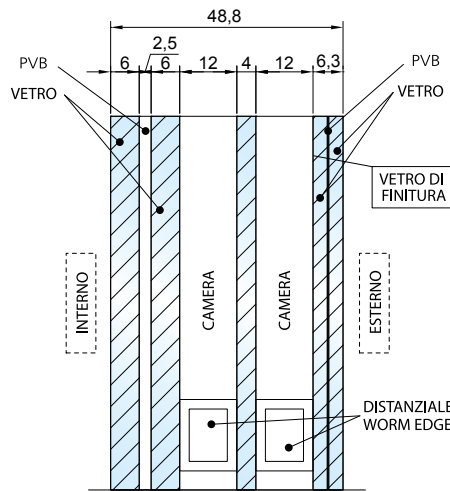

Stratobel 66.6 basso emissivo magnetronico -
12mm Argon 90% - 4mm Planibel clear -
12mm Argon 90% - Stratobel 33.1 trasparente

SULLE PORTE BLINDATE A VETRO ALIAS NON SONO PRESENTI CORNICI FERMA VETRO MA VENGONO PANTOGRAFATI I PANNELLI DI RIVESTIMENTO INTERNI ED ESTERNI IN MODO DA DETERMINARE LA SAGOMA DELLA FINISTRATURA. FRA IL VETRO E IL PANNELLO È PRESENTE UNA GUARNIZIONE ISOLANTE.

The ALIAS security doors with glass inlays do not feature glass securing frames but the inside and outside panels are pantograph-machined so as to determine the shape of the glass section. An insulation gasket is inserted between the glass and the panel.

En las puertas acorazadas en vidrio ALIAS, no hay marcos para-vidrio pero vienen pantografados los tableros de revestimiento internos y externos de manera tal que se cree la forma de la ventana. Entre el vidrio y el tablero se encuentra una guarnición aislante.

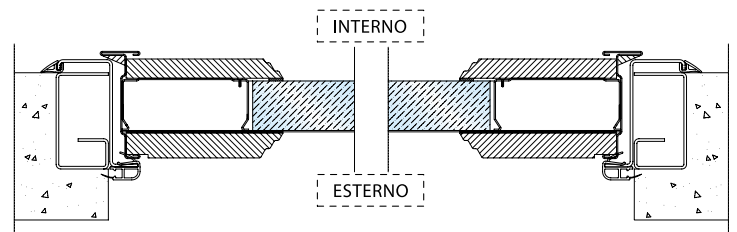

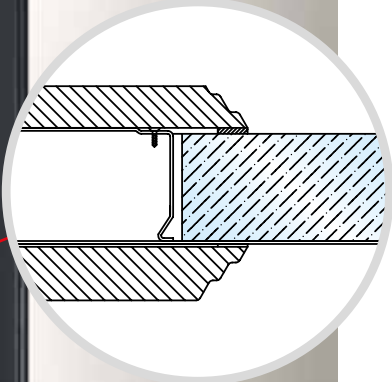

SOPRALUCE E FIANCHILUCE

Glass transom and side glass
Lumbreras y vidrios de lado



ALIAS PRODUCE CON LA CURA ARTIGIANALE DI UN ATELIER, PORTE FINESTRATE E CON SOPRALUCE A MISURA, RIVESTITE ALL'INTERNO DA LEGNO MASSICCIO

Glass doors and on demand transom glass, with internal solid wood panel produced with a craftsman care.

Alias fabrica puertas en vidrios y puertas con lumbrera con la cura artesanal de un ATELIER y utiliza para el lado interior madera maciza.

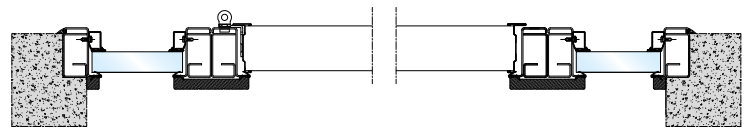

SEZIONE ORIZZONTALE ANTA CON DUE FIANCHI LUCE
Horizontal section of a leaf with two side glasses
Sección horizontal hoja con dos vidrios de lado

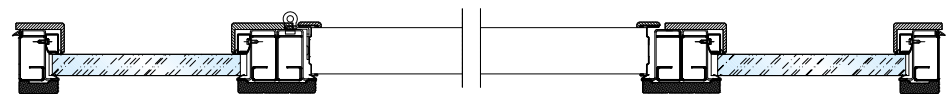

SEZIONE ORIZZONTALE ANTA CON DUE FIANCHI LUCE COMPLETA DEL KIT ATELIER PER INTERNO
Horizontal section of the leaf with 2 side glass including Atelier Kit for inside
Sección horizontal hoja con dos fijos laterales completa con Kit Atelier para interno

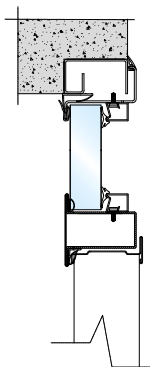

SEZIONE VERTICALE ANTA CON SOPRALUCE
Vertical section of transom glass leaf
Sección vertical hoja con lumbrera

SOPRALUCE CON APERTURA VASISTAS

Glass transom with wasistas

Lumbreras con vasistas

VASISTAS CON APERTURA MECCANICA O MOTORIZZATA. IL MOTORE È INTEGRATO, A SCOMPARSO, NEL TELAIO.

Mechanical or motorized opening wasistas, the engine is hidden and integrated in the frame.

Vasistas con apertura mecánica o motorizada. El motor, escamoteable, está integrado en la estructura.

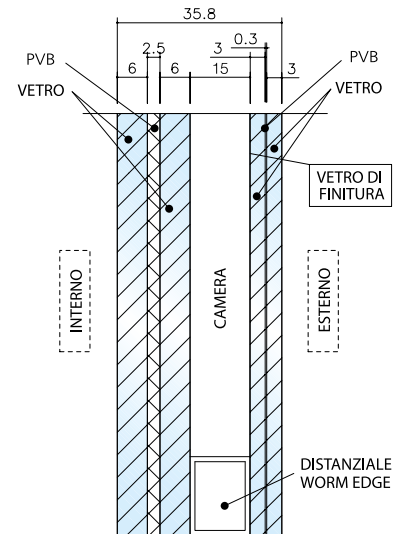

Stratobel 66.6 basso emissivo magnetronico -
15mm Argon 90% - Stratobel 33.1 trasparente



SERRATURA MOTORIZZATA

Motorized lock

Cerradura con motor



ENTER

SEMPLICE E FUNZIONALE, ENTER È LA SERRATURA BASE PROPOSTA DA ALIAS. DOTATA DI PULSANTE INTERNO PER L'APERTURA DELLA PORTA, PREVEDE LA CHIUSURA AUTOMATICA DEI CATENACCI CON IL MERO ACCOSTAMENTO DELL'ANTA.

QUESTA SERRATURA, QUINDI, PERMETTE DI ENTRARE ED USCIRE AGEVOLMENTE DALLA PROPRIA ABITAZIONE SENZA L'UTILIZZO DELLA CHIAVE TRADIZIONALE (PUR SEMPRE UTILIZZABILE).

ESTERNAMENTE È DOTATA DI TASTIERA ALFANUMERICA. LA SUA ALIMENTAZIONE AVVIENE TRAMITE UNA BATTERIA O UN PASSACAPO COLLEGATO ALL'IMPIANTO ELETTRICO.

PREVEDE IL MONTAGGIO DI UNA MANIGLIA PASSANTE O UN POMOLO FISSO ESTERNO.

“Enter” is the simple and functional basic lock proposed by ALIAS. This type of lock is provided with an internal button that opens the door, besides when the leaf closes, the bolts are automatically extracted and the door is locked. This lock allows you to exit and enter your home easily without using the traditional key (that in any case can be used). In the external side, the lock is provided with an alphanumeric keyboard. The lock can be power supplied by batteries or wired to the home electric board. This lock allows to install the moving handle (both external and internal side) but also an external fixed knob.

Simple y funcional, ENTER es la cerradura base que ALIAS propone. Esta cerradura tiene un boton interno para abrir la puerta y permite el cierre de la puerta simplemente acercando la hoja. Eso permite entrar y salir comodamente de casa sin utilizar la llave tradicional (que se puede sin embargo utilizar si necesario). En el lado externo tiene un teclado numerico. Su alimentacion es posible con bateria o protector de cable, conectado al sistema electrico. Posible montar manija interna y externa o pomolo fijo exterior.



EASY

E' LA SERRATURA DI FASCIA INTERMEDIA DI ALIAS. OLTRE A POSSEDERE TUTTE LE CARATTERISTICHE PROPRIE DELLA ENTER, QUINDI A ESSERE GOVERNATA DA UN SISTEMA ELETTRONICO AUTOMATICO CHE PERMETTE DI FARE A MENO DELLA CHIAVE TRADIZIONALE (PUR SEMPRE UTILIZZABILE), PREVEDE UNA TASTIERA ESTERNA CHE FUNGE ANCHE DA RICEVITORE PER IL TRANSPONDER, QUINDI CONSENTE L'APERTURA TRAMITE BADGE. CON EASY È INOLTRE POSSIBILE CONFIGURARE 5 MODALITÀ DI PROGRAMMAZIONE DIVERSE. PUÒ ESSERE ALIMENTATA TRAMITE BATTERIA O PASSACAVO COLLEGATO ALL'IMPIANTO ELETTRICO E MONTARE UNA MANIGLIA PASSANTE PIUTTOSTO CHE UN POMOLO FISSO ESTERNO.

It belongs to the intermediate category of locks by ALIAS. This lock has got not only all the characteristics of the "Enter" model, but also an automatic electronic system that allows you to do without the traditional key (that in any case can be used). It is provided with an external keyboard that works also as receiver for the transponder and that allows to open the door with the card. This lock allows you to configure 5 different programs. The lock can be power supplied by batteries or wired to the home electric board. Besides, this lock allows to install a moving handle (both external and internal side) but also an external fixed knob.

Esta es la cerradura del grupo intermedio ALIAS. Además de las otras características de la cerradura ENTER el modelo EASY tiene un teclado externo que funciona como receptor para el transponder y permite de abrir utilizando un badge. Con Easy es posible configurar 5 modos de programación diferentes. La alimentación es con batería o protector de cable, conectado al sistema eléctrico. Posible montar manija interna y externa o pomolo fijo externo.

SERRATURA MOTORIZZATA

Motorized lock

Cerradura con motor



SMART

TOP DI GAMMA DI ALIAS, LA SERRATURA SMART È GOVERNATA DA UN SOFISTICATO SISTEMA ELETTRONICO AUTOMATICO, CHE PERMETTE IL CONTROLLO DA REMOTO DEGLI ACCESSI DI CASA ATTRAVERSO IL PROPRIO SMARTPHONE.

BASTA SCARICARE L'APPOSITA APP GRATUITA, E IN POCHI SEMPLICI PASSAGGI SI POTRÀ AVERE IL TOTALE CONTROLLO DELL'INGRESSO DI CASA. SMART, INOLTRE, È CERTIFICATA PER LE PORTE TAGLIAFUOCO FINO A 90 MINUTI.

LA SUA ALIMENTAZIONE PUÒ AVVENIRE TRAMITE BATTERIA O TRAMITE PASSACAVO COLLEGATO ALL'IMPIANTO ELETTRICO OPPURE CON ENTRAMBI CONTEMPORANEAMENTE.

NON È PREVISTA LA PULSANTIERIA INTERNA DI APERTURA IN QUANTO UTILIZZA UN SISTEMA ANTIPANICO IN GRADO DI PERMETTERE L'APERTURA AGENDO SEMPLICEMENTE SULLA MANIGLIA; OVVIAMENTE PREVEDE LA CHIUSURA AUTOMATICA DEI CATENACCI CON IL MERO ACCOSTAMENTO DELL'ANTA.

L'ELEGANTE TASTIERA ALFANUMERICA ESTERNA PUÒ ESSERE ABBINATA AD UN RICEVITORE A SCOMPARSA PER IL TRASPONDER, PREVEDENDO ANCHE L'APERTURA TRAMITE BADGE.

E' POSSIBILE CONFIGURARE 3 MODALITÀ DI PROGRAMMAZIONE .

It represents the top of the locks by ALIAS. This model has got a sophisticated automatic electronic system that permits its remote control by means of your Smartphone. The only thing you have to do is download the APP, completely free, and in few simple steps you will have the total control of your house entryway. Besides, "SMART" for fire doors is 90 minutes certified. The lock can be power supplied by batteries or wired to the home electric board or both. In this solution there is no internal button to open the door, but it uses an emergency lock system that allows to open the door simply by pushing the handle. When the leaf closes, the bolts are automatically extracted and the door is locked. The sophisticated alphanumeric keyboard can be combined with an hidden receiver for the transponder. The door can be opened also with the card. Besides, it is possible to configure the lock with 3 different programs.

Este modelo es la cerradura de ultima generacion de Alias; esa tiene un sistema electronico muy sofisticado qui permite de controlar las entradas simplemente utilizando el propio smartphone. Es necesario descargar la APP gratuita y con algunos simples pasajes serà posible tener la supervision de las entradas. SMART es certificada tambien para puertas corta fuego 90 minutos. La alimentacion es con bateria o protector de cable, conectado al sistema electrico o con los dos juntos. No hay botones internos porque se puede abrir la puerta simplemente bajando la manija; el cierre de la puerta ocurre acercando la hoja. El teclado elegante externo se puede acompañar con un receptor para el transponder y permite abrir utilizando un badge. Es posible configurar 3 modos de programacion diferentes.



OPTIONAL LETTORE BIOMETRICO
Biometric reader
Lector biometrico

VISION - VISORE DIGITALE

Vision Digital viewer

Vision

IL NUOVO SISTEMA ELETTRONICO CON VISORE DIGITALE SCELTO DA ALIAS PER SOSTITUIRE LO SPIONCINO TRADIZIONALE OTTENENDO UNA VISIONE CHIARA DI ALTA QUALITÀ. PERCHÈ UTILIZZARE IL VISORE DIGITALE? PERCHÈ POSSIAMO NOTARE I BENEFICI DI UN'IMMAGINE CHIARA E INGRANDITA. CON LO SPIONCINO TRADIZIONALE L'IMMAGINE È POVERA, LE PERSONE ANZIANE VEDONO CON DIFFICOLTÀ ALL'ESTERNO E I BAMBINI NON POSSONO RAGGIUNGERE L'OCCHIOLO A CAUSA DELL'ALTEZZA. IL VISORE DIGITALE SI ACCENDE SEMPLICEMENTE PREMENDO UN PULSANTE E SUBITO APPARE L'IMMAGINE SUL DISPLAY.

The new electronic system with digital viewer by Alias to replace the traditional spy-hole to get a high quality vision. Why to use the digital viewer? The digital viewer offers larger and clearer imagine. The traditional spy-hole offers a poor imagine and it doesn't let elderly people look outside easily and children can't reach the spy-hole because of the height. The digital viewer turns on pressing a button and immediately the imagines appears on the display.

Es el nuevo sistema electronico con visor digital elegido por Alias para reemplazar la mirilla tradicional para obtener una vision clara de calidad. Porque utilizar un visor digital? Con el visor digital podemos obtener beneficios de una imagen clara y agrandada. Con la mirilla tradicional la imagen es pobre, las personas mayores ven con dificultad hacia el exterior y los niños no pueden llegar a la mirilla por la altura. El visor digital se enciende simplemente presionando un boton y enseguida aparece la imagen en el display.



8 cm

12 cm

CARATTERISTICHE TECNICHE TECHNICAL FEATURES / CARACTERISTICAS TECNICAS

- Modello - Model - Modelo: **WISO.51.xx**
- Attacco qualsiasi porta - Attach - Pega para puerta: **55-110 mm di sp.**

- Sensore - Sensor - Sensor: **0.3 Mega Pixel CMOS**
- Schermo LCD - LCD screen - Pantalla LCD
- Fonte di energia - Energy alimentation - Fuente de energia: **4 batterie stilo AA - 4 batteries 4 baterias stilo AA**
- Peso: - Weight: - Peso: **350g**

INSTALLAZIONE/installation/installacion

TRAPANARE UN FORO DI 14MM NELLA PORTA A LIVELLO DELL'OCCHIO. INSERIRE LA TELECAMERA DALL'ESTERNO E ASSICURARSI CHE LA FRECCIA DAVANTI ALLA TELECAMERA PUNTI VERSO L'ALTO. MONTARE LA PIASTRA SOPRA L'ESTREMITÀ DELLE LENTI QUINDI AVVITARE IL CILINDRO DI BLOCCAGGIO ALLA PARTE FILETTATA DELLA TELECAMERA. SUCCESSIVAMENTE FISSARE LA PIASTRA CON 2 VITI (FORNITE). ASSICURARSI CHE LA FRECCIA SULLA PIASTRA PUNTI VERSO L'ALTO. IL FILO DELLA TELECAMERA DEVE ESSERE COLLEGATO ALLA PRESA DI CORRENTE NELLA PARTE POSTERIORE DEL VISORE. AGGANCIARE IL VISORE DELLA PORTA DIGITALE ATTRAVERSO LA STAFFA NELLA PARTE SUPERIORE DELLA PIASTRA DI CHIUSURA E FISSARE INSERENDO DUE VITI NEI FORI DEI BOTTONI DELLA CASSA DEL VISORE.

Make a hole of 14mm in the door at the eye-level. Insert the camera from the external side and make sure that the arrow in front of it is pointing up. Install the plate on the ends of the lens and screw the cylinder of the lock to the threaded side of the camera. After that fix the plate with two screws (provided). Make sure that the arrow on the plate is pointing up. The cable of the camera should be connected to the socket with the back side of the viewer. Hook the digital viewer of the door through the bracket in the up side of the plate of the lock and fix it using two screws.

Hacer un agujero de 14mm en la puerta a nivel del ojo. Insertar la camara desde el exterior y asegurarse que la flecha alante de la camara esté dirigida hacia arriba. Instalar la placa sobre la extremidad de los lentes y tornillar el cilindro de cierre a la parte roscada de la camara. Luego fijar la placa con 2 tornillos (puerta equipada de tornillos). Asegurarse que la flecha de la placa esté dirigida hacia arriba. El hilo de la camara tiene que estar conectado del enchufe que se encuentra en el lado abajo del visor digital. Pegar el visor digital a la puerta utilizando el estribo en el lado arriba de la placa de cierre y fijar con insercion de dos tornillos en los agujeros de los botones de la caja del visor.

KANT

PORTAOMBRELLI COORDINATO ALLE PRODUZIONI ALIAS PORTE BLINDATE. EVENTUALMENTE PUÒ ESSERE UTILIZZATO ANCHE COME VASO PORTAFIORI. ELEGANTE, MODERNO, SEMPLICE, DI FACILE INSTALLAZIONE E UTILIZZO. FACILMENTE ADATTABILE A QUALSIASI SPAZIO E CONTESTO ABITATIVO. STRUTTURA IN METALLO VERNICIATO A POLVERI COLOR ALLUMINIO, CON FACCE DISPONIBILI IN METACRILATO BIANCO/ROSSO/NERO E LEGNO WENGÉ.

To house your umbrellas, coordinate to Alias production. You can also use it as a jar. Elegant, modern and very easy to install. It fits to every space and house. Its structure is made with aluminum coloured powders, with possible colours among white/red/black and wengé.

Paraguero en combinacion con la produccion Alias de puertas acorazadas. Se puede utilizar como florero. Elegante, moderno, simple, facil de utilizar e instalar. Se adapta a cualquier espacio y contexto de habitacion. Estructura en metal pintado con pintura en polvo color aluminio y caras disponibles en metacrilado blanco / rojo / negro y madera roble wengé.



40 cm



60 cm



FINITURA TELAI E PROFILI PERIMETRALI

Frames finishing and perimetral profiles
Acabados para bastidor y perfiles
perimetrales

È POSSIBILE SCEGLIERE LA FINITURA DEL TELAIO
E DEL PROFILO PERIMETRALE DELLA PORTA FRA I
SEGUENTI COLORI :

It is possible to choose the frame finishings and
perimetral profiles among the following colours:

Es posible escojer el acabado para el bastidor
y los perfiles perimetrales de la puerta entre los
siguientes colores:



nero
black
negro



alluminio
aluminium
aluminio



tanganica
tanganyika
Nogal
tanganika



rovere
oak
roble



mogano
mahogany
caoba



wengé
wengé
roble wengé



bianco
white
blanco



testa di moro
dark brown
marron oscuro
simile al
RAL 8017

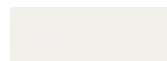

perla
pearl
perla
simile al
RAL 1013



Brunitech

ABBINANDO AI RIVESTIMENTI INTERNI IN LEGNO LE NOSTRE FINITURE
ROVERE - WENGÉ - MOGANO - NOCE È POSSIBILE OTTENERE UN
EFFETTO DI TOTALE UNIFORMITÀ E PREGIO.

By matching the internal wood door with our OAK - WENGÉ -
MAHOGANY - WALNUT finishes, it is possible to achieve an effect
of complete uniformity and quality.

Utilizando junto a los revestimientos internos en madera nuestros
acabados ROBLE - WENGÉ - CAOBA es posible obtener un efecto
de prestigio.

UTILIZZANDO L'ALLUMINIO SI POSSONO OTTENERE ABBINAMENTI
DALLO STILE DECISAMENTE PIÙ CONTEMPORANEO SIA CON I
RIVESTIMENTI IN LEGNO CHE CON QUELLI LACCATI.

The use of aluminium enables to create combinations with a
decidedly more contemporary style for both wood and lacquered
finishing.

Utilizando el aluminio se pueden obtener soluciones con un estilo
más contemporaneo con los revestimientos en madera y lacados.

È CONSIGLIATO CON QUESTA SOLUZIONE L'ABBINAMENTO DEI
RIVESTIMENTI INTERNI ED ESTERNI DEL MEDESIMO BIANCO RAL
9016. SE NON FOSSE POSSIBILE RISPETTARE QUEST'OSSERVANZA
È DISPONIBILE UNA GUARNIZIONE NERA CHE RIVESTE IL PROFILO
PERIMETRALE ALL'ESTERNO DELL'ANTA IN MODO CHE NON SIA
VISIBILE IL COLORE BIANCO QUANDO LA PORTA SI TROVA CHIUSA.

This solution is recommended to finish the internal and external
door panels with the same RAL 9016 colour. If this is not possible,
a black strip can be applied along the outer profile so that the white
colour cannot be seen when the door is closed.

Se aconseja utilizar para los revestimientos internos y externos el
mismo blanco RAL 9016. Si no es posibles utilizar el mismo blanco
se puede utilizar una guarnición negra que cubre el perfil alrededor
de la hoja, de esta manera cuando la puerta está cerrada no se
nota el color blanco.



TINTE LEGNO

Wood colours
Tintas madera



ALLUMINIO

Aluminium
Aluminio



BIANCO

White
Blanco

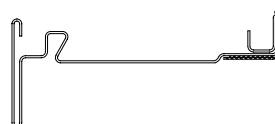

GUARNIZIONE PER CARENA BICOLORE

Two coloured strip
For outer profile

KIT DI TRATTAMENTO E PROTEZIONE

Maintenance and protection Kit

Kit de protecció n y tratamiento

CON UNA SEMPLICE OPERAZIONE DI MANUTENZIONE, DA EFFETTUARSI OGNI SEI MESI, È POSSIBILE COMBATTERE IL NATURALE INVECCHIAMENTO DEL LEGNO. IL KIT COMPRENDE DUE PRODOTTI, UNO DETERGENTE E L'ALTRO PROTETTIVO DA APPLICARE SU TUTTI I NOSTRI RIVESTIMENTI.

It is possible to prevent the natural wood ageing with a simple maintenance operation to be done every 6 months. The kit includes 2 products: a detergent and protective product that can be used for all our panels.

Haciendo una operaci3n simple de mantenimiento cada seis meses es posible luchar contra el envejecimiento de la madera. El kit est3 compuesto por dos productos, uno detergente y uno de protecci3n que hay que aplicar a todos nuestros tableros.



CONTROTELAIO

Secondary frames

Contramarco

ALIAS HA UN CONTROTELAIO STANDARD CHE UNA VOLTA MURATO A REGOLA D'ARTE PUÒ ACCOGLIERE TUTTE LE TIPOLOGIE DI PORTE, SIA QUELLE CON CERNIERA A VISTA CHE QUELLE CON CERNIERA A SCOMPARSA. TUTTAVIA È POSSIBILE, PER ESIGENZE DI POSA, SCEGLIERE ALTRE TIPOLOGIE DI CONTROTELAIO QUI A FIANCO INDICATE.

ALIAS has a standard secondary frame that after being perfectly embedded in the wall can house any type of door, with external or invisible hinges. However, should the door installation require it, it is possible to choose further types of secondary frames as shown on the right.

ALIAS tiene un contromarco est3ndard, una vez colocado perfectamente en la pared puede utilizar cualquier tipo de puertas, de igual manera la puertas con bisagras invisibles y visibles. Si necesario es tambi3n posible escoger otros tipos de contromarco, indicados al lado.

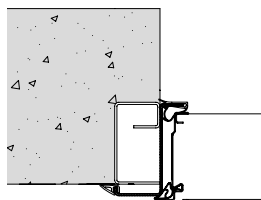

**CONTROTELAIO
STANDARD**

Standard secondary frame
Contramarco estandard

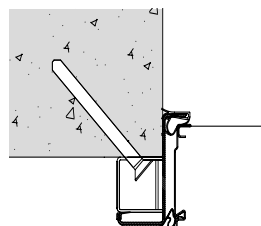

**CONTROTELAIO
FRANCESE**

French secondary frame
Contramarco frances

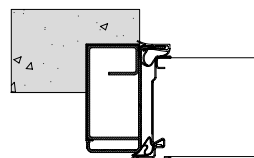

**CONTROTELAIO
GENOVESE**

Genoese secondary frame
Contramarco Genoves

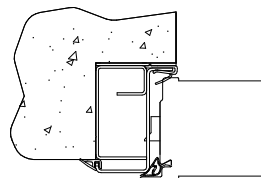

**CONTROTELAIO
FILO INTONACO**

Counter frame flush with the wall
Contramarco ras de la pared

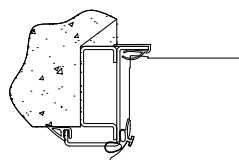

**CONTROTELAIO
PER PORTA ZTL**

ZTL secondary frame
Contramarco ZTL

INGOMBRI TECNICI

- STEEL - VEGA PLUS - STEEL C FB6
- SILVER - GOLD - PLATINUM
- TITANIUM - MAGMA 39/60/90

Technical sizes

Dimensiones tècnicas

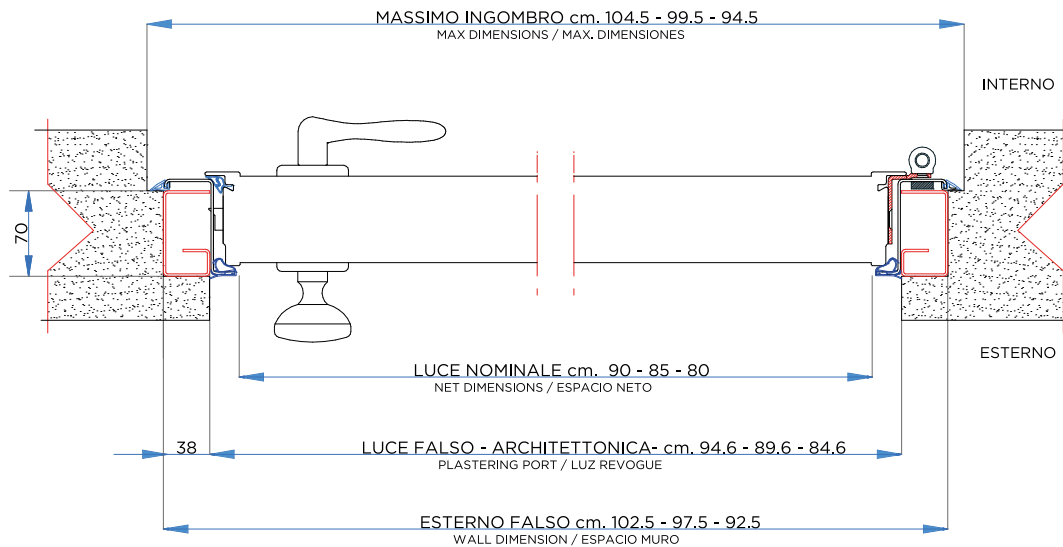
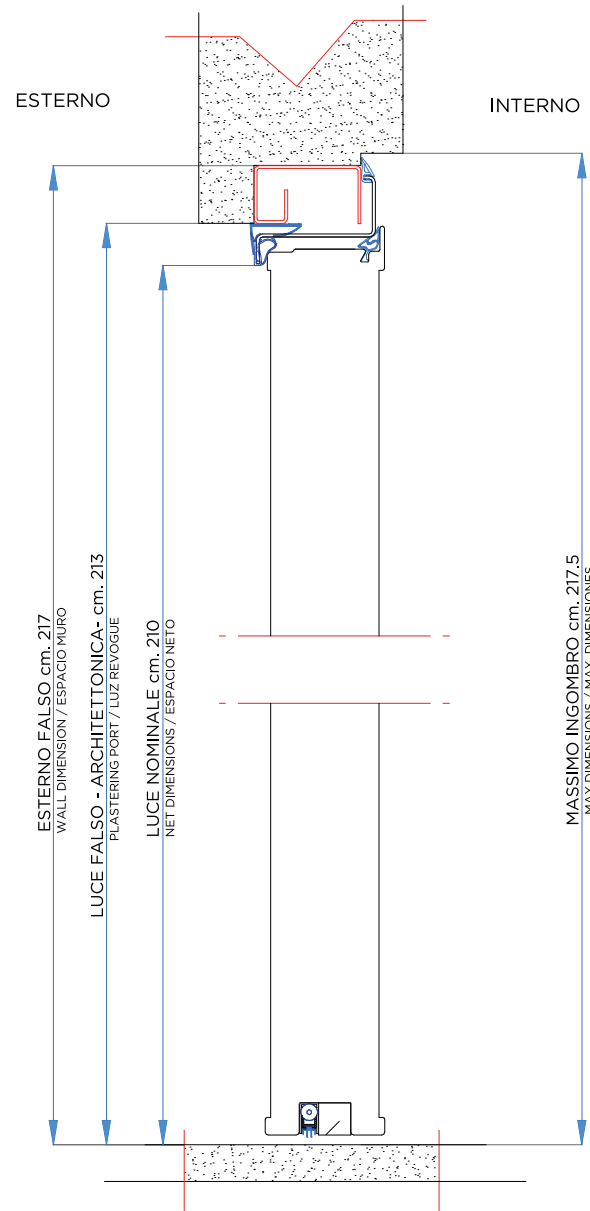
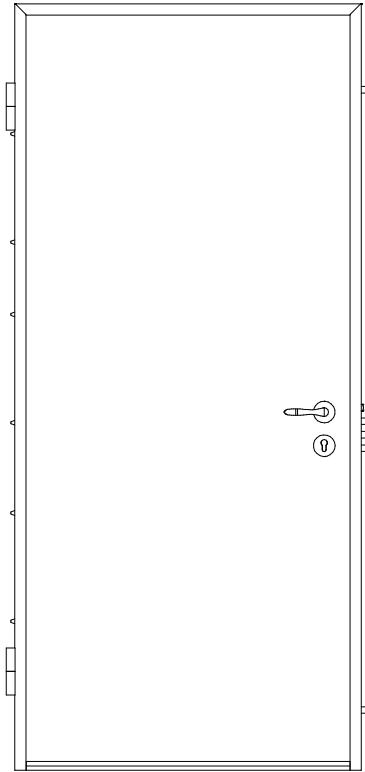

INGOMBRI TECNICI ZTL

Technical sizes ZTL

Dimensiones tècnicas ZTL

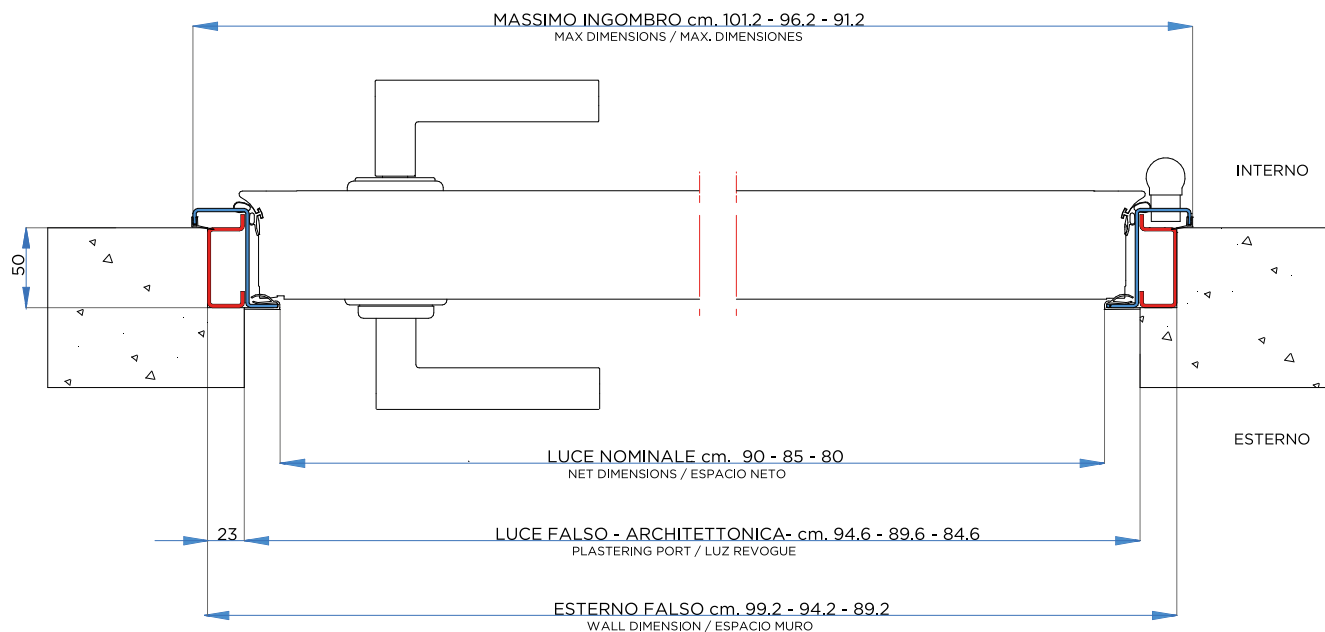
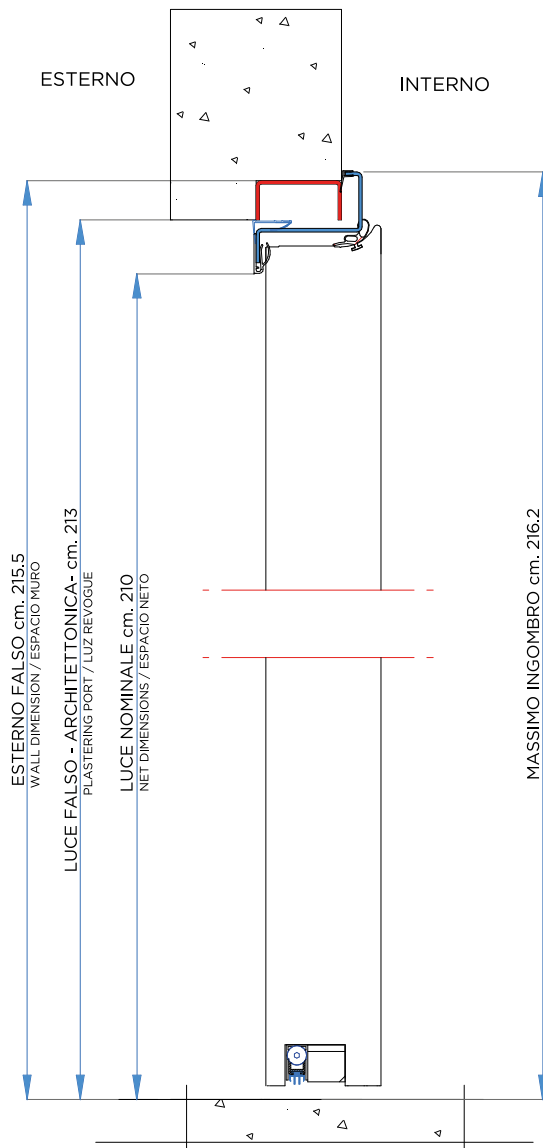
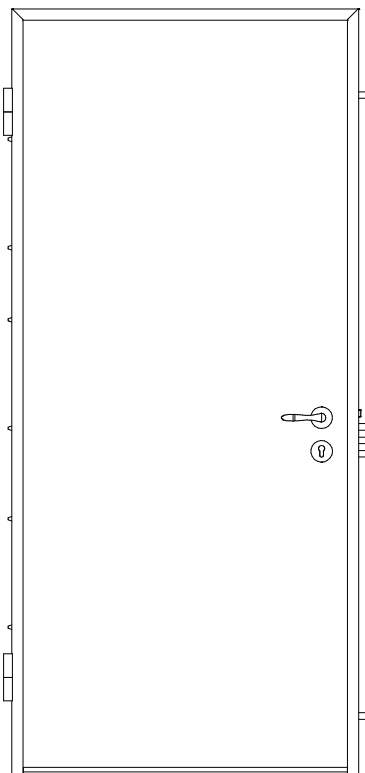

INGOMBRI TECNICI ZTL IN LUCE

Outside wall ZTL technical dimensions

Dimensiones tècnicas ZTL
montada en el muro externo

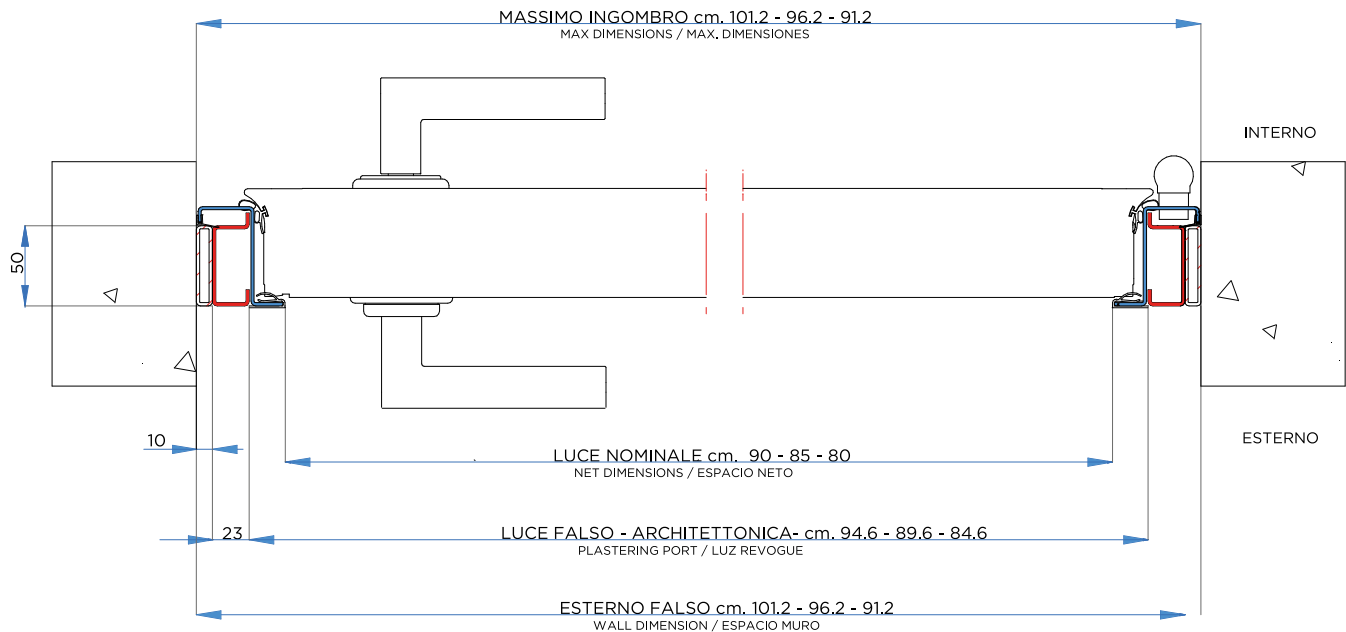
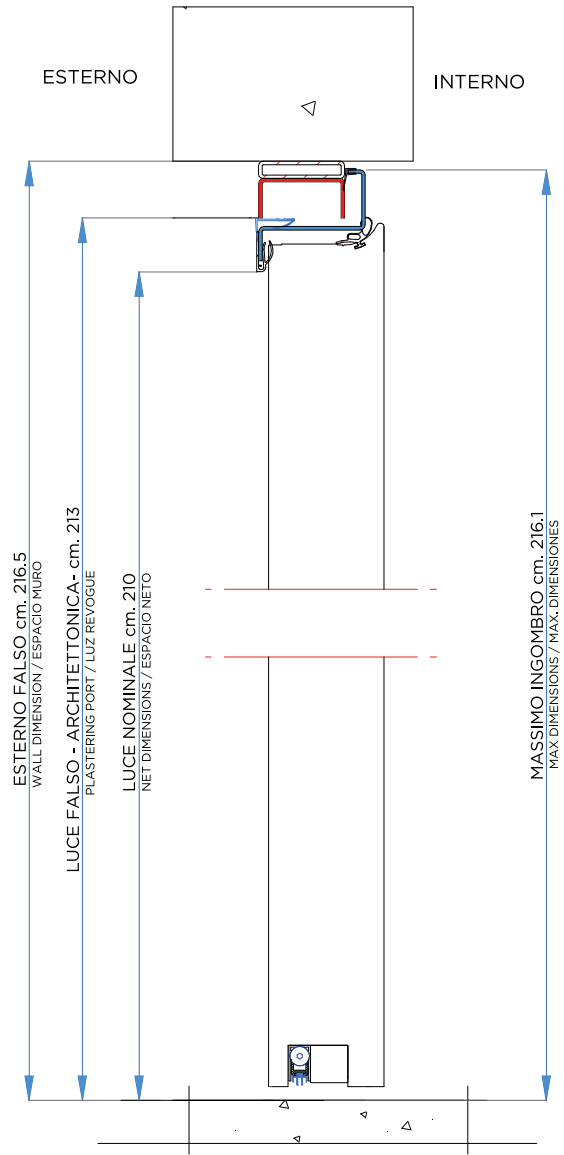
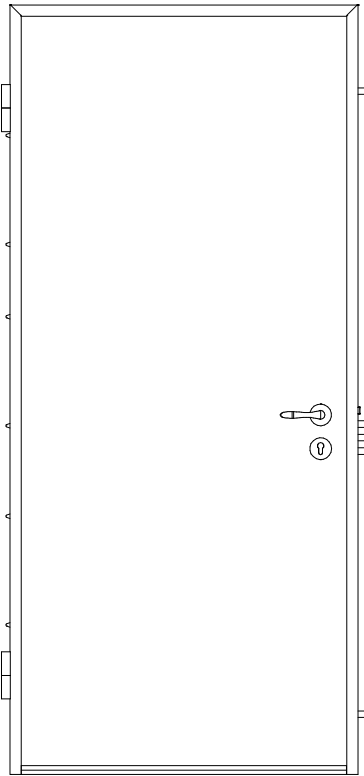

BATTUTA A PAVIMENTO A SCELTA

Bar floor

Umbrales a elegir

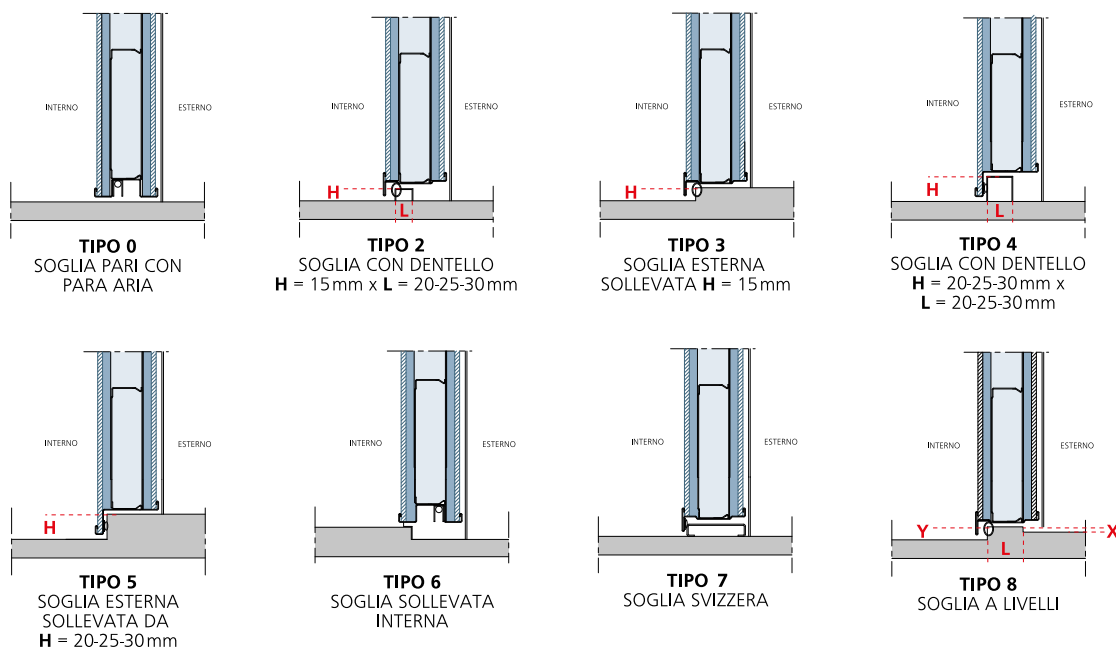

PRESTAZIONI AGGIUNTIVE AAV/dB

Additional features AAV/dB

Prestaciones adjuntas AAV/dB

ALIAS PROPONE DUE NUOVE SOLUZIONI TECNICHE DALLE ALTE PRESTAZIONI, SIA PER LA PORTA BLINDATA DA ESTERNO CHE PER QUELLA DA CONDOMINIO; SONO APPLICABILI A TUTTI I MODELLI DELLA GAMMA AD ANTA SINGOLA.

ALIAS offers two new high technical performance solutions for both exterior and interior entry doors. These solutions can be fitted to all single-leaf door models.

ALIAS propone dos nuevas soluciones técnicas de gran calidad para las puertas acorazadas para exterior y para edificios; se pueden aplicar a todos los modelos con una sólo hoja.

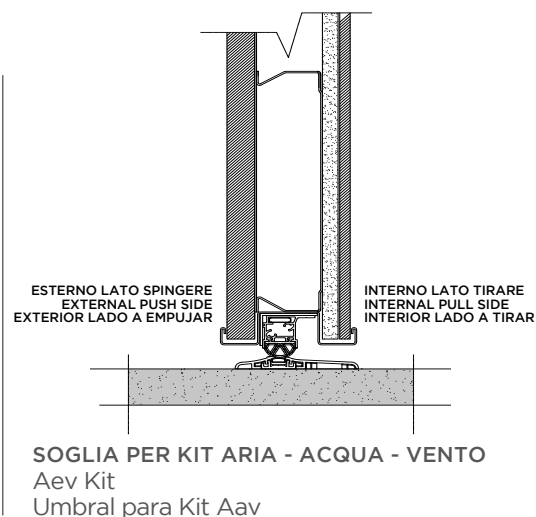

Set di resistenza e tenuta ad ARIA - ACQUA - VENTO AEV Kit - Kit AAV

CARATTERISTICHE CERTIFICATE DEL SET:

Certified features:
Características certificadas incluidas en el set:

	Metodo di prova Norma Test method Metodo de prueba ley	Classificazione Norma Rule classification Clasificacion Ley	Classe Class Clase
Permeabilità all'aria - Air resistance - Resistencia al aire	EN 1026	EN 12207	4
Tenuta all'acqua - Water resistance - Resistencia al agua	EN 1027	EN 12208	5A
Resistenza al carico del vento Wind resistance - Resistencia al viento	EN 12211	EN 12210	C5

PER PORTE BLINDATE DA ESTERNO SOLO PER MODELLO STEEL 1 ANTA.

For security door for outside only for Steel model, one leaf.

Para puertas para el exterior nada mas para modelos de puertas con una hoja.

CERTIFICATI

Certificates

Certificados

ALIAS COLLABORA CON I PIÙ IMPORTANTI ISTITUTI DI CONTROLLO E CERTIFICAZIONE RICONOSCIUTI A LIVELLO EUROPEO PER GARANTIRE AL MEGLIO LE PRESTAZIONI E LA QUALITÀ DEI PROPRI PRODOTTI. DI SEGUITO L'ELENCO DEI PRINCIPALI CERTIFICATI E RAPPORTI DI PROVA ATTUALMENTE OTTENUTI.

ALIAS cooperates with all the major European organizations for testing and certification in order to guarantee the best performance and quality of its products. The following list includes the most important certificates and test reports obtained by ALIAS to date.

ALIAS colabora con los más importantes institutos de control y certificaciones reconocidos a nivel Europeo para garantizar lo mejor posible las prestaciones y la calidad de los propios productos. A seguir la lista de los principales certificados y relaciones de prueba actualmente obtenidos.

ISO 9001:2008

ISTITUTO INSTITUTION INSTITUTO	N.º	DATA DATE FECHA	TITOLO TITLE TITULO	PRESTAZIONE PERFORMANCE PRESTACIONES	MODELLO MODEL MODELO	NORME RULES LEYES
TUV	Certificato N° 50 100 8737	28/05/15	UNI EN ISO 9001:2008	Certificazione di sistema	-	ISO 9001:2008

RESISTENZA ALL'EFFRAZIONE - Burglar resistance - Resistencia a la efracción

ISTITUTO INSTITUTION INSTITUTO	N.º	DATA DATE FECHA	TITOLO TITLE TITULO	PRESTAZIONE PERFORMANCE PRESTACIONES	MODELLO MODEL MODELO	NORME RULES LEYES
CSI	Rapporto di prova 0061-DC-AEF-10/1	08/07/11	Effrazione	Classe 2	DUO DOUBLE	EN 1627-1628-1629-1630
Istituto Giordano	Rapporto di prova 221408	29/01/07	Effrazione	Classe 3	STEEL	EN 1627-1628-1629-1630
Istituto Giordano	Rapporto di prova 221407	29/01/07	Effrazione	Classe 3	STEEL	EN 1627-1628-1629-1630
CNPP	Rapp. D'essai n° MD 030073	18/12/03	Effrazione	Classe 3	FORTEX	EN 1627-1628-1629-1630
CNPP	Rapp. D'essai n° MD 030072	12/02/08	Effrazione	Classe 3	SECUREX	EN 1627-1628-1629-1630
Istituto Giordano	Rapporto di prova 222871	07/03/07	Effrazione	Classe 4	PLATINUM TITANIUM	EN 1627-1628-1629-1630
CSI	Rapporto di prova 0028-DC-AEF-14	17/06/14	Effrazione	Classe 4	VEGAPLUS	EN 1627-1628-1629-1630
CNPP	Rapp. D'essai n° MD 040123A	04/02/05	Effrazione	Classe 4	FORTEX SECUREXPLUS	EN 1627-1628-1629-1630

RESISTENZA ALL'EFFRAZIONE - Burglar resistance - Resistencia a la efracción

ISTITUTO INSTITUTION INSTITUTO	N.°	DATA DATE FECHA	TITOLO TITLE TITULO	PRESTAZIONE PERFORMANCE PRESTACIONES	MODELLO MODEL MODELO	NORME RULES LEYES
CNPP	Certificato 39.184-01	2006	Effrazione	A2P*	Serratura CISA New cambio facile Doppia mappa	REGOLAMENTO CNPP
CNPP	Certificato 39.238-01	2011	Effrazione	A2P*	Serratura CISA Revolution HF e Cilindro	REGOLAMENTO CNPP
CNPP	Certificato 39.305-61	2013	Effrazione	A2P**	Serratura CISA New cambio facile HG Doppia mappa	REGOLAMENTO CNPP
CNPP	Certificato 39.314-61	2014	Effrazione	A2P**	Serratura CISA Revolution HG Cilindro	REGOLAMENTO CNPP
CNPP	Certificato 19.65	2014	Serrures de batiment	BP1	Securex	REGOLAMENTO CNPP

RESISTENZA AL PROIETTILE - Bullet resistance - Antibalas

ISTITUTO INSTITUTION INSTITUTO	N.°	DATA DATE FECHA	TITOLO TITLE TITULO	PRESTAZIONE PERFORMANCE PRESTACIONES	MODELLO MODEL MODELO	NORME RULES LEYES
Banco nazionale di prova per le armi da fuoco	Rapporto di prova N° 30/BAL-AG/VP	24/03/14	Balistica	FB6	STEEL	1522:2000

TENUTA ARIA ACQUA VENTO - Air-Water-Wind permeability - Permeabilidad Aire-Agua-Viento

ISTITUTO INSTITUTION INSTITUTO	N.°	DATA DATE FECHA	TITOLO TITLE TITULO	PRESTAZIONE PERFORMANCE PRESTACIONES	MODELLO MODEL MODELO	NORME RULES LEYES
CSI	Rapporto di Prova N° 0161-DC- AAV-09-1	28/10/14	Tenuta AAV	Aria: Classe 2 Acqua: NPD Vento: C2	STEEL SILVER	EN 1026- 1027-12211
CSI	Rapporto di Prova N° 0161-DC- AAV-09-2	20/12/13	Tenuta AAV	Aria: Classe 4 Acqua: 5A Vento: C5	STEEL SILVER	EN 1026- 1027-12211
Istituto Giordano	Rapporto di Prova N° 267193-5060- CPD	16/03/10	Tenuta AAV	Aria: Classe 4 Acqua: 8A Vento: C4	STEEL SILVER SOPRARLUCE MAX FINESTRATA	EN 1026- 1027-12211
CEBTP	Dossier N° BP13-6-4119-1	29/09/2006	Tenuta AAV	Aria: Classe 2 Acqua: 4B Vento: A5	STEEL SILVER	EN 1026- 1027-12211

TRASMITTANZA TERMICA - Thermal transmittance - Transmitancia térmica

ISTITUTO INSTITUTION INSTITUTO	N.°	DATA DATE FECHA	TITOLO TITLE TITULO	PRESTAZIONE PERFORMANCE PRESTACIONES	MODELLO MODEL MODELO	NORME RULES LEYES
CSI	Rapporto di prova N°0049-DC-AEF-11-4	22/09/11	Calcolo termico	1,3	STEEL-SILVER ECC.	14351-1
CSI	Rapporto di prova N°0049-DC-AEF-11-3	07/09/11	Calcolo termico	1	FLAT	14351-1
CSI	Rapporto di prova N°0049-DC-AEF-11	07/09/11	Calcolo termico	1,01	WALL	14351-1
CSI	Rapporto di prova N°0057-DC-AEF-14	16/01/15	Calcolo termico	1,4	ZTL	14351-1
CSI	Rapporto di prova N°0056-DC-AEF-14	12/12/14	Calcolo termico	1,2 - 1,2 - 1,1	STEEL-SILVER	14351-1

PRESTAZIONE ACUSTICA - Acoustic performance - Aislamiento acústico

ISTITUTO INSTITUTION INSTITUTO	N.°	DATA DATE FECHA	TITOLO TITLE TITULO	PRESTAZIONE PERFORMANCE PRESTACIONES	MODELLO MODEL MODELO	NORME RULES LEYES
CSI SpA	Rapporto di prova 0140-DC-ACU-10	07/10/10	Isolamento acustico	34 dB	STEEL SILVER	ISO 140/3 - 717/1
CSI SpA	Rapporto di prova 0058-DC-ACU-13-2	24/03/14	Isolamento acustico	37 dB	STEEL SILVER	ISO 140/3 - 717/1
CSI SpA	Rapporto di prova 0054B-DC-ACU-08	07/10/10	Isolamento acustico	40 dB	STEEL SILVER	ISO 140/3 - 717/1
CSI SpA	Rapporto di prova 0044-DC-ACU-13	25/11/13	Isolamento acustico	40 dB	STEEL - SILVER CON SOPRALUCE	ISO 140/3 - 717/1
CSI SpA	Rapporto di prova 0058-DC-ACU-13-1	24/03/14	Isolamento acustico	40 dB	STEEL SILVER	ISO 140/3 - 717/1
Istituto Giordano	Rapporto di prova 180813	03/03/04	Isolamento acustico	42 dB	STEEL SILVER GOLD	ISO 140/3 - 717/1
CSI SpA	Rapporto di prova 0030-DC-ACU-10	13/09/10	Isolamento acustico	44 dB	STEEL SILVER	ISO 140/3 - 717/1
CSI SpA	Rapporto di prova 0054C-DC-ACU-08	22/09/08	Isolamento acustico	35 dB	STEEL - SILVER FINESTRATA (SPECCHIATURA)	ISO 140/3 - 717/1
CSI SpA	Rapporto di prova 0054D-DC-ACU-08	22/09/08	Isolamento acustico	31 dB	DUO - DOUBLE 2 ANTE	ISO 140/3 - 717/1
CSI SpA	Rapp. D'essai N° AC03-128/1	30/01/04	Isolamento acustico	41 dB	SECUREX	ISO 140/3 - 717/1
CSI SpA	Rapp. D'essai N° AC03-128/2	30/01/04	isolamento acustico	40 dB	FORTEX	ISO 140/3 - 717/1
Istituto Giordano	Rapporto di prova 180812	03/03/04	isolamento acustico	38 dB	MAGMA-C	ISO 140/3 - 717/1
CSI SpA	Rapporto di prova 0021-DC-ACU-12/1	14/06/12	isolamento acustico	42 dB	MAGMA-C	ISO 140/3 - 717/1

PRESTAZIONE ACUSTICA - Acoustic performance - Aislamiento acústico

ISTITUTO INSTITUTION INSTITUTO	N.°	DATA DATE FECHA	TITOLO TITLE TITULO	PRESTAZIONE PERFORMANCE PRESTACIONES	MODELLO MODEL MODELO	NORME RULES LEYES
CSI SpA	Rapporto di prova 0021-DC-ACU-12/2	06/10/12	isolamento acustico	40dB	MAGMA-C	ISO 140/3 - 717/1
CSI SpA	Rapporto di prova 0034-DC-ACU-13	03/10/13	isolamento acustico	35 dB - 42dB	MAGMA-30	ISO 140/3 - 717/1
CSI SpA	Rapporto di prova 0061-DC-ACU-11/1	28/02/13	isolamento acustico	36dB - 38dB	WING WALL	ISO 140/3 - 717/1
CSI SpA	Rapporto di prova 0061-DC-ACU-11/2	07/03/13	isolamento acustico	39dB	WING WALL	ISO 140/3 - 717/1
CSI SpA	Rapporto di prova 0011\DC\ ACU\15\1+all1	11/05/15	isolamento acustico	35-41 dB	Ztl	ISO 140/3-717/1

RESISTENZA AL FUOCO - Fire resistance - Resistencia al fuego

ISTITUTO INSTITUTION INSTITUTO	N.°	DATA DATE FECHA	TITOLO TITLE TITULO	PRESTAZIONE PERFORMANCE PRESTACIONES	MODELLO MODEL MODELO	NORME RULES LEYES
CSI SpA	Rapp. di prova CSI1421FR	20/10/08	Prova di resistenza al fuoco	EI1 30	MAGMA EI1 30	EN 1634-1
CSI SpA	Rapp. di prova CSI1401FR PC201REI030P002	30/06/08	Prova di resistenza al fuoco	EI2 30	MAGMA 30	EN 1634-1
EFFECTIS	P. V. 11-A-044	14/04/11	Prova di resistenza al fuoco	EI2 30	MAGMA 30	EN 1634-1
Istituto Giordano	Rapp. di prova 179557/2593RF omolog. C201REI060P001F1	14/07/04	Prova di resistenza al fuoco	REI60	MAGMA C	EN 1634-1
VKF	Rapp. di class. n. 20293	17/05/10	Prova di resistenza al fuoco	EI2 30	MAGMA 30	EN 1634-1
PAVUS A.S.	C216/C5A/2016/0065	31/05/16	Prova di resistenza al fuoco	EI2 30	MAGMA 30	EN 1634-1
ZAG	REG2-00004-03- ZGPro1-2734	24/06/16	Prova di resistenza al fuoco	EI2 30	MAGMA 30	EN 1634-1
EFFECTIS	PV 11-V-163	09/05/11	Prova di resistenza al fuoco	EI2 30	SECUREX	EN 1634-1
CSI SpA	Rapp. di prova CSI1726FR	14/02/11	Prova di resistenza al fuoco	EI2 30	FORTEX	EN 1634-1
EFFECTIS	PV 12-A-399P	10/07/12	Prova di resistenza al fuoco	EI2 30	FORTEX	EN 1634-1
CSI SpA	Rapp. di prova CSI1694FR	28/10/11	Prova di resistenza al fuoco	EI2 30	"SECUREX renovation"	EN 1634-1
EFFECTIS	PV 12-A-069P	21/02/12	Prova di resistenza al fuoco	EI2 30	"SECUREX renovation"	EN 1634-1
CSI SpA	Rapp. di prova CSI1781FR omolog. PC201EI2060P003	02/07/12	Prova di resistenza al fuoco	EI2 60	WALL EI2 60	EN 1634-1
VKF	Rapp. di prova n. 26016	01/04/15	Prova di resistenza al fuoco	EI2 60	WALL EI2 60	EN 1634-1
CSI SpA	Rapp. di prova CSI1764FR omolog. PC201EI2045P006	05/06/12	Prova di resistenza al fuoco	EI2 45	STEEL CF 15	EN 1634-1
CSI SpA	Rapp. di prova CSI1874FR omolog. PC201EI2060P003	12/03/13	Prova di resistenza al fuoco	EI2 30	MAGMA CS30	EN 1634-1
CSI SpA	Rapp. di prova CSI1919FR omolog. PC201EI2060P004	10/07/13	Prova di resistenza al fuoco	EI2 60	MAGMA C EI2 60	EN 1634-1

PRESTAZIONI

Features

Prestaciones

Famiglia Model Modelo	Accessori Optionals Accesorios	Cod.agg. Code Codigo	Descrizione Description Descripción	Effrazione Anti Burglary Efracción UNI ENV-1627 1628 - 1630	Acustica Acoustic Acustico ISO 717 ISO 140	Termica Thermic Termico UNI EN 10077-1-2	Aria-Acqua-Vento Air-Water-Wind Aire-Agua-Viento EN 1026 - 1027 12211	Fuoco Fire Fuego UNI 9723 1634 ARRETE 03/08/09
STEEL-SILVER STEELPLUS GOLD			Liscio + liscio	Classe 3	34 dB	1,3 W/ (m ² · K)	2-NPD-C2	NPD
			Liscio CCE + liscio CCE	Classe 3	34 dB	1,3 W/ (m ² · K)	2-NPD-C2	NPD
		A54B	Liscio + liscio + AWW - Ulisse -	Classe 3	34 dB	1,3 W/ (m ² · K)	4-5A-C5	NPD
		BASV	liscio + liscio + soglia svizzera	Classe 3	34 dB	1,3 W/ (m ² · K)	2-4B-A5	NPD
		SO	Liscio + liscio + sopra luce	NPD	34 dB	1,5 W/ (m ² · K)	NPD	NPD
		SO	A54B Liscio + liscio + sopra luce +AWW - Ulisse -	NPD	34 dB	1,5 W/ (m ² · K)	4-5A-C5	NPD
		PA	Liscio + pantografato	Classe 3	34 dB	1,6 W/ (m ² · K)	2-NPD-C2	NPD
		PA	6X16 Liscio + pantografato 6X16	Classe 3	34 dB	1,3 W/ (m ² · K)	2-NPD-C2	NPD
		PA	Liscio CCE + pantografato	Classe 3	34 dB	1,6 W/ (m ² · K)	2-NPD-C2	NPD
		PA	6X16 Liscio CCE + pantografato 6X16	Classe 3	34 dB	1,3 W/ (m ² · K)	2-NPD-C2	NPD
		PA	A54B Liscio + pantografato + AWW - Ulisse	Classe 3	34 dB	1,6 W/ (m ² · K)	4-5A-C5	NPD
		PA	A54B 6X16 Liscio + pantografato 6X16 +AWW - Ulisse -	Classe 3	34 dB	1,3 W/ (m ² · K)	4-5A-C5	NPD
		PABASV	Liscio + pantografato + soglia svizzera	Classe 3	34 dB	1,6 W/ (m ² · K)	2-4B-A5	NPD
		BASV	6X16 Liscio + pantografato 6X16 + soglia svizzera	Classe 3	34 dB	1,3 W/ (m ² · K)	2-4B-A5	NPD
		SOPA	Liscio + pantografato + sopra luce	NPD	34 dB	1,7 W/ (m ² · K)	NPD	NPD
		SOPA	6X16 Liscio + pantografato 6X16 + sopra luce	NPD	34 dB	1,5 W/ (m ² · K)	NPD	NPD
		SOPA	A54B Liscio + pantografato + sopra luce + AWW - Ulisse -	NPD	34 dB	1,7 W/ (m ² · K)	4-5A-C5	NPD
		SOPA	A54B 6X16 Liscio + pantografato 6X16 + sopra luce + AWW - Ulisse -	NPD	34 dB	1,5 W/ (m ² · K)	4-5A-C5	NPD
		PAPA	Pant + pant	Classe 3	34 dB	2,0 W/ (m ² · K)	2-NPD-C2	NPD
		PAPA	6X16 Pant + pant 6X16	Classe 3	34 dB	1,3 W/ (m ² · K)	2-NPD-C2	NPD
	PAPABA	Pant + Pant + soglia svizzera	Classe 3	34 dB	2,0 W/ (m ² · K)	2-4B-A5	NPD	
	PAPABA	6X16 Pant + Pant 6X16 + soglia svizzera	Classe 3	34 dB	1,3 W/ (m ² · K)	2-4B-A5	NPD	
	SOPAPA	Pan + Pant + sopra luce	NPD	34 dB	2,2 W/ (m ² · K)	NPD	NPD	
	SOPAPA	6X16 Pan + Pant 6X16 + sopra luce	NPD	34 dB	1,5 W/ (m ² · K)	NPD	NPD	

Famiglia Model Modelo	Accessori Optionals Accesorios	Cod.agg. Code Codigo	Descrizione Description Descripción	Effrazione Anti Burglary Efracción UNI ENV-1627 1628 - 1630	Acustica Acoustic Acustico ISO 717 ISO 140	Termica Thermic Termico UNI EN 10077-1-2	Aria-Acqua-Vento Air-Water-Wind Aire-Agua-Viento EN 1026 - 1027 12211	Fuoco Fire Fuego UNI 9723 1634 ARRETE 03/08/09
	PAPA	A54B	Pan + Pant + AWW - Ulisse -	Classe 3	34 dB	2,0 W/ (m ² · K)	4-5A-C5	NPD
	PAPA	A54B 6X16	Pan + Pant 6X16 + AWW - Ulisse-	Classe 3	34 dB	1,5 W/ (m ² · K)	4-5A-C5	NPD
			Liscio + liscio	Classe 3	37 dB	1,2 W/ (m ² · K)	2-NPD-C2	NPD
			Liscio CCE + liscio CCE	Classe 3	37 dB	1,2 W/ (m ² · K)	2-NPD-C2	NPD
		A54B	Liscio + liscio+ AWW - Ulisse -	Classe 3	37 dB	1,2 W/ (m ² · K)	4-5A-C5	NPD
	BASV		liscio + liscio + soglia svizzera + AWW tipo vecchio	Classe 3	37 dB	1,2 W/ (m ² · K)	2-4B-A5	NPD
	PA		Liscio + pantografato	Classe 3	37 dB	1,4 W/ (m ² · K)	2-NPD-C2	NPD
	PA	6X16	Liscio + pantografato 6X16	Classe 3	37 dB	1,2 W/ (m ² · K)	2-NPD-C2	NPD
	PA		Liscio CCE + pantografato	Classe 3	37 dB	1,4 W/ (m ² · K)	2-NPD-C2	NPD
	PA	6X16	Liscio CCE + pantografato 6X16	Classe 3	37 dB	1,2 W/ (m ² · K)	2-NPD-C2	NPD
	PA	A54B	Liscio + pantografato + AWW - Ulisse -	Classe 3	37 dB	1,4 W/ (m ² · K)	4-5A-C5	NPD
	PA	A54B 6X16	Liscio + pantografato 6X16 +AWW - Ulisse -	Classe 3	37 dB	1,2 W/ (m ² · K)	4-5A-C5	NPD
	PABASV		Liscio + pantografato + soglia svizzera	Classe 3	37 dB	1,4 W/ (m ² · K)	2-4B-A5	NPD
	BASV	6X16	Liscio + pantografato 6X16 + soglia svizzera	Classe 3	37 dB	1,2 W/ (m ² · K)	2-4B-A5	NPD
	PAPA		Pan + Pant	Classe 3	37 dB	1,8 W/ (m ² · K)	2-NPD-C2	NPD
	PAPA	6X16	Pan + Pant 6X16	Classe 3	37 dB	1,2 W/ (m ² · K)	2-NPD-C2	NPD
	PAPABA		Pan + Pant + soglia svizzera	Classe 3	37 dB	1,8 W/ (m ² · K)	2-4B-A5	NPD
	PAPABA	6X16	Pan + Pant 6X16 + soglia svizzera	Classe 3	37 dB	1,2 W/ (m ² · K)	2-4B-A5	NPD
	PAPA	A54B	Pan + Pant + AWW - Ulisse -	Classe 3	37 dB	1,8 W/ (m ² · K)	4-5A-C5	NPD
	PAPA	A54B 6X16	Pan + Pant 6X16+AWW - Ulisse-	Classe 3	37 dB	1,2 W/ (m ² · K)	4-5A-C5	NPD
		40 dB	Liscio + liscio + kit 40 dB	Classe 3	40 dB	1,2 W/ (m ² · K)	2-NPD-C2	NPD
		40 dB	Liscio CCE + liscio CCE	Classe 3	40 dB	1,2 W/ (m ² · K)	2-NPD-C2	NPD
	PA	40 dB	Liscio + pantografato + kit 40 dB	Classe 3	40 dB	1,8 W/ (m ² · K)	2-NPD-C2	NPD
	PA	40 dB 6x16	Liscio + pantografato 6X16 + kit 40 dB	Classe 3	40 dB	1,2 W/ (m ² · K)	2-NPD-C2	NPD
	PA	40 dB	Liscio CCE + pantografato + Kit 40 dB	Classe 3	40 dB	1,7 W/ (m ² · K)	2-NPD-C2	NPD
	PA	40 dB 6x16	Liscio CCE + pantografato 6X16 + Kit 40 dB	Classe 3	40 dB	1,2 W/ (m ² · K)	2-NPD-C2	NPD
	PAPA	40 dB	Pant + Pant + kit 40 dB	Classe 3	40 dB	2,0 W/ (m ² · K)	2-NPD-C2	NPD

Famiglia Model Modelo	Accessori Optionals Accesorios	Cod.agg. Code Codigo	Descrizione Description Descripción	Effrazione Anti Burglary Efracción UNI ENV-1627 1628 - 1630	Acustica Acoustic Acustico ISO 717 ISO 140	Termica Thermic Termico UNI EN 10077-1-2	Aria-Acqua-Vento Air-Water-Wind Aire-Agua-Viento EN 1026 - 1027 12211	Fuoco Fire Fuego UNI 9723 1634 ARRETE 03/08/09
	PAPA	40 dB 6x16	Pant + Pant 6X16 + kit 40 dB	Classe 3	40 dB	1,2 W/ (m ² ·K)	2-NPD-C2	NPD
	SO	40 dB	Liscio + liscio + kit 40 dB + sopraluce	NPD	40 dB	1,5 W/ M ² K	NPD	NPD
	SOPA	40 dB	Liscio + Pant + kit 40 dB + sopraluce	NPD	40 dB	1,8 W/ (m ² ·K)	NPD	NPD
	SOPA	40 dB 6x16	Liscio + Pant 6X16 + kit 40 dB + sopraluce	NPD	40 dB	1,5 W/ (m ² ·K)	NPD	NPD
	SOPAPA	40 dB	Pant + Pant + kit 40 dB + sopraluce	NPD	40 dB	2,1 W/ (m ² ·K)	NPD	NPD
	SOPAPA	40 dB 6x16	Pant + Pant 6X16 + kit 40 dB + sopraluce	NPD	40 dB	1,5 W/ (m ² ·K)	NPD	NPD
		40 dB	Liscio + liscio + kit 40 dB + soglia AWW - Ulisse -	Classe 3	40 dB	1,2 W/ (m ² ·K)	4-5A-C5	NPD
		40 dB	Liscio + liscio + kit 40 dB + soglia svizzera	Classe 3	40 dB	1,2 W/ (m ² ·K)	4-5A-C5	NPD
		40 dB 6x16	Liscio + pantografato 6X16 + kit 40 dB + soglia AWW - Ulisse -	Classe 3	40 dB	1,2 W/ (m ² ·K)	4-5A-C5	NPD
		40 dB 6x16	Liscio + pantografato 6X16 + kit 40 dB + soglia svizzera	Classe 3	40 dB	1,2 W/ (m ² ·K)	4-5A-C5	NPD
		40 dB 6x16	Pant + Pant 6X16 + kit 40 dB + soglia AWW - Ulisse -	Classe 3	40 dB	1,2 W/ (m ² ·K)	4-5A-C5	NPD
		40 dB 6x16	Pant + Pant 6X16 + kit 40 dB + soglia svizzera	Classe 3	40 dB	1,2 W/ (m ² ·K)	4-5A-C5	NPD
		42 dB	Liscio + liscio	Classe 3	42 dB	1,6 W/ (m ² ·K)	2-NPD-C2	NPD
		42 dB	Liscio CCE + liscio CCE	Classe 3	42 dB	1,6 W/ (m ² ·K)	2-NPD-C2	NPD
	PA	42 dB	Liscio + pantografato	Classe 3	42 dB	2,0 W/ (m ² ·K)	2-NPD-C2	NPD
	PA	42 dB 6x16	Liscio + pantografato 6X16	Classe 3	42 dB	1,6 W/ (m ² ·K)	2-NPD-C2	NPD
	PA	42 dB	Liscio CCE + pantografato	Classe 3	42 dB	2,0 W/ (m ² ·K)	2-NPD-C2	NPD
	PA	42 dB 6x16	Liscio CCE + pantografato 6X16	Classe 3	42 dB	1,6 W/ (m ² ·K)	2-NPD-C2	NPD
	PAPA	42 dB	Pan + Pant	Classe 3	42 dB	2,4 W/ (m ² ·K)	2-NPD-C2	NPD
	PAPA	42 dB 6x16	Pan + Pant 6X16	Classe 3	42 dB	1,6 W/ (m ² ·K)	2-NPD-C2	NPD
	SO	42 dB	Liscio + liscio + sopraluce	NPD	NPD	1,8 W/ (m ² ·K)	NPD	NPD
	SOPA	42 dB	Liscio + pantografato + sopraluce	NPD	NPD	2,0 W/ (m ² ·K)	NPD	NPD
	SOPA	42 dB 6x16	Liscio + pantografato 6X16 + sopraluce	NPD	NPD	1,8 W/ (m ² ·K)	NPD	NPD
	SOPAPA	42 dB	Pan + Pant + sopraluce	NPD	NPD	2,4 W/ (m ² ·K)	NPD	NPD
	SOPAPA	42 dB 6x16	Pan + Pant 6X16 + sopraluce	NPD	NPD	1,8 W/ (m ² ·K)	NPD	NPD
		44 dB	Liscio + liscio	Classe 3	44 dB	1,6 W/ (m ² ·K)	2-NPD-C2	NPD
		44 dB	Liscio CCE + liscio CCE	Classe 3	44 dB	1,6 W/ (m ² ·K)	2-NPD-C2	NPD

Famiglia Model Modelo	Accessori Optionals Accesorios	Cod.agg. Code Codigo	Descrizione Description Descripción	Effrazione Anti Burglary Efracción UNI ENV-1627 1628 - 1630	Acustica Acoustic Acustico ISO 717 ISO 140	Termica Thermic Termico UNI EN 10077-1-2	Aria-Acqua-Vento Air-Water-Wind Aire-Agua-Viento EN 1026 - 1027 12211	Fuoco Fire Fuego UNI 9723 1634 ARRETE 03/08/09
	PA	44 dB	Liscio + pantografato	Classe 3	44 dB	2,0 W/ (m ² · K)	2-NPD-C2	NPD
	PA	44 dB 6x16	Liscio + pantografato 6X16	Classe 3	44 dB	1,6 W/ (m ² · K)	2-NPD-C2	NPD
	PA	44 dB	Liscio CCE + pantografato	Classe 3	44 dB	2,0 W/ (m ² · K)	2-NPD-C2	NPD
	PA	44 dB 6x16	Liscio CCE + pantografato 6X16	Classe 3	44 dB	1,6 W/ (m ² · K)	2-NPD-C2	NPD
	PAPA	44 dB	Pant + Pant	Classe 3	44 dB	2,4 W/ (m ² · K)	2-NPD-C2	NPD
	PAPA	44 dB 6x16	Pant + Pant 6X16	Classe 3	44 dB	1,6 W/ (m ² · K)	2-NPD-C2	NPD
	SO	44 dB	Liscio + liscio + sopra luce	NPD	NPD	1,8 W/ (m ² · K)	NPD	NPD
	SOPA	44 dB	Liscio + Pant + sopra luce	NPD	NPD	2,0 W/ (m ² · K)	NPD	NPD
	SOPA	44 dB 6x16	Liscio + Pant 6X16 + sopra luce	NPD	NPD	1,8 W/ (m ² · K)	NPD	NPD
	SOPAPA	44 dB	Pant + Pant + sopra luce	NPD	NPD	2,4 W/ (m ² · K)	NPD	NPD
	SOPAPA	44 dB 6x16	Pant + Pant 6X16 + sopra luce	NPD	NPD	1,8 W/ (m ² · K)	NPD	NPD
	PAPAFI		Pant + pant MAX finestrata	NPD	35 dB	2,2 W/ (m ² · K)	NPD	NPD
	PAPAFI		Pant + pant MAX finestrata tipo nuovo	NPD	41 dB	1,3 W/ (m ² · K)	NPD	NPD
	SOPAPAFI		Pant + pant MAX finestrata + sopra luce	NPD	NPD	2,3 W/ (m ² · K)	NPD	NPD
	SOPAPAFI		Pant + pant MAX finestrata + sopra luce tipo nuovo	NPD	NPD	1,6 W/ (m ² · K)	NPD	NPD
	PAPAFI	A54B	Pant + pant MAX finestrata +AWW - Ulisse -	NPD	35 dB	2,2 W/ (m ² · K)	4-5A-C5	NPD
	PAPAFI	A54B	Pant+pant MAX finestratura tipo nuovo + AWW - Ulisse -	NPD	41 dB	1,6 W/ (m ² · K)	4-5A-C5	NPD
DUO-DOUBLE			Liscio + liscio	Classe 3	31 dB	1,4 W/ (m ² · K)	NPD	NPD
			Liscio CCE + liscio CCE	Classe 3	31 dB	1,4 W/ (m ² · K)	NPD	NPD
		A54B	Liscio + liscio + AWW	Classe 3	31 dB	1,4 W/ (m ² · K)	NPD	NPD
	BASV		Liscio + liscio + soglia svizzera	Classe 3	31 dB	1,4 W/ (m ² · K)	NPD	NPD
	SO		Liscio + liscio + sopra luce	NPD	NPD	1,6 W/ (m ² · K)	NPD	NPD
	SO	A54B	Liscio + liscio + sopra luce + AWW	NPD	NPD	1,6 W/ (m ² · K)	NPD	NPD
	PA		Liscio + pantografato	Classe 3	31 dB	1,6 W/ (m ² · K)	NPD	NPD
	PA	6x16	Liscio + pantografato 6X16	Classe 3	31 dB	1,4 W/ (m ² · K)	NPD	NPD
	PA		Liscio CCE + pantografato	Classe 3	31 dB	1,6 W/ (m ² · K)	NPD	NPD
	PA	6x16	Liscio CCE + pantografato 6X16	Classe 3	31 dB	1,4 W/ (m ² · K)	NPD	NPD

Famiglia Model Modelo	Accessori Optionals Accesorios	Cod.agg. Code Codigo	Descrizione Description Descripción	Effrazione Anti Burglary Efracción UNI ENV-1627 1628 - 1630	Acustica Acoustic Acustico ISO 717 ISO 140	Termica Thermic Termico UNI EN 10077-1-2	Aria-Acqua-Vento Air-Water-Wind Aire-Agua-Viento EN 1026 - 1027 12211	Fuoco Fire Fuego UNI 9723 1634 ARRETE 03/08/09
	PA	A54B	Liscio + pantografato + aria + acqua + vento	Classe 3	31 dB	1,6 W/ (m ² · K)	NPD	NPD
	PA	A54B 6x16	Liscio + pantografato 6X16 +AWW	Classe 3	31 dB	1,4 W/ (m ² · K)	NPD	NPD
	PABASV		Liscio + pantografato + soglia svizzera	Classe 3	31 dB	1,6 W/ (m ² · K)	NPD	NPD
	BASV	6x16	Liscio + pantografato 6X16 + soglia svizzera	Classe 3	31 dB	1,4 W/ (m ² · K)	NPD	NPD
	SOPA		Liscio + pantografato + sopraluce	NPD	NPD	1,8 W/ (m ² · K)	NPD	NPD
	SOPA	6x16	Liscio + pantografato 6X16 + sopraluce	NPD	NPD	1,6 W/ (m ² · K)	NPD	NPD
	SOPA	A54B	Liscio + pantografato + sopraluce + AWW	NPD	NPD	1,8 W/ (m ² · K)	NPD	NPD
	SOPA	A54B 6x16	Liscio + pantografato 6X16 + sopraluce + AWW	NPD	NPD	1,8 W/ (m ² · K)	NPD	NPD
	PAPA		Pant + pant	Classe 3	31 dB	2,0 W/ (m ² · K)	NPD	NPD
	PAPA	6x16	Pant + pant 6X16	Classe 3	31 dB	1,4 W/ M ² K	NPD	NPD
	PAPABASV		Pant + Pant + soglia svizzera	Classe 3	31 dB	2,0 W/ M ² K	NPD	NPD
	BASV	6x16	Pant + Pant 6X16 + soglia svizzera	Classe 3	31 dB	1,4 W/ (m ² · K)	NPD	NPD
	SOPAPA		Pant + pant + sopraluce	NPD	NPD	2,0 W/ (m ² · K)	NPD	NPD
	SOPAPA	6x16	Pant + pant 6X16 + sopraluce	NPD	NPD	1,6 W/ (m ² · K)	NPD	NPD
	PAPA	A54B	Pant + pant+AWW	Classe 3	34 dB	2,0 W/ (m ² · K)	NPD	NPD
	PAPA	A54B 6x16	Pant + pant 6X16+AWW	Classe 3	34 dB	1,4 W/ (m ² · K)	NPD	NPD
	PAPAFI		Pant + pant MAX finestrata	NPD	NPD	2,2 W/ (m ² · K)	NPD	NPD
	PAPAFI		Pant + pant MAX finestrata tipo nuovo	NPD	NPD	1,4 W/ (m ² · K)	NPD	NPD
	PAPAFIFI		Finestrata ANTA E ANTINO	NPD	NPD	2,4 W/ (m ² · K)	NPD	NPD
	PAPAFIFI		Finestrata ANTA E ANTINO tipo nuovo	NPD	NPD	1,6 W/ (m ² · K)	NPD	NPD
	SOPAPAFI		Pant + pant MAX finestrata + SOPRALUCE	NPD	NPD	2,8W/ (m ² · K)	NPD	NPD
	SOPAPAFI		Pan + Pant MAX finestrata tipo nuovo + SOPRALUCE	NPD	NPD	1,6 W/ (m ² · K)	NPD	NPD
	SOPAPAFIFI		Finestrata ANTA E ANTINO + sopraluce	NPD	NPD	2,6 W/ (m ² · K)	NPD	NPD
	SOPAPAFIFI		Finestrata ANTA E ANTINO tipo nuovo +sopraluce	NPD	NPD	1,8 W/ (m ² · K)		
STEEL 762FJ ANTIPROIETTILE				Classe 3	34 dB	NPD	2-NPD-C2	NPD

Famiglia Model Modelo	Accessori Optionals Accesorios	Cod.agg. Code Codigo	Descrizione Description Descripción	Effrazione Anti Burglary Efracciòn UNI ENV-1627 1628 - 1630	Acustica Acoustic Acustico ISO 717 ISO 140	Termica Thermic Termico UNI EN 10077-1-2	Aria-Acqua-Vento Air-Water-Wind Aire-Agua-Viento EN 1026 - 1027 12211	Fuoco Fire Fuego UNI 9723 1634 ARRETE 03/08/09
ZTL	35 dB -2;-4 Standard		Liscio + liscio	Classe 3	34 dB	1,4 W/ (m ² · K)	NPD-NPD- NPD	NPD-NPD- NPD
			Liscio CCE + liscio CCE	Classe 3	34 dB	1,4 W/ (m ² · K)	NPD-NPD- NPD	NPD-NPD- NPD
				Classe 3	34 dB	1,4 W/ (m ² · K)	NPD-NPD- NPD	NPD-NPD- NPD
	BASV		Liscio + liscio + soglia svizzera	Classe 3	34 dB	1,4 W/ (m ² · K)	NPD-NPD- NPD	NPD-NPD- NPD
	PA		Liscio + pantografato	Classe 3	34 dB	1,4 W/ (m ² · K)	NPD-NPD- NPD	NPD-NPD- NPD
	PA	6X16	Liscio + pantografato 6X16	Classe 3	34 dB	1,4 W/ (m ² · K)	NPD-NPD- NPD	NPD-NPD- NPD
	PA		Liscio CCE + pantografato	Classe 3	34 dB	1,4 W/ (m ² · K)	NPD-NPD- NPD	NPD-NPD- NPD
	PA	6X16	Liscio CCE + pantografato 6X16	Classe 3	34 dB	1,4 W/ (m ² · K)	NPD-NPD- NPD	NPD-NPD- NPD
	PABASV		Liscio + pantografato + soglia svizzera	Classe 3	34 dB	1,4 W/ (m ² · K)	NPD-NPD- NPD	NPD-NPD- NPD
	BASV	6X16	Liscio + pantografato 6X16 + soglia svizzera	Classe 3	34 dB	1,4 W/ (m ² · K)	NPD-NPD- NPD	NPD-NPD- NPD
KIT	41 dB -1;-5 (porta fornita con para aria acustico)			Classe 3	40 dB	1,4 W/ (m ² · K)	NPD-NPD- NPD	NPD-NPD- NPD
PLATINUM TITANIUM VEGA PLUS			Liscio + liscio	Classe 4	34 dB	1,8 W/ (m ² · K)	NPD	NPD
			Liscio CCE + liscio CCE	Classe 4	34 dB	1,8 W/ (m ² · K)	NPD	NPD
	BASV		liscio + liscio + soglia svizzera	Classe 4	34 dB	1,8 W/ (m ² · K)	NPD	NPD
	SO		Liscio + liscio + sopraluce	NPD	NPD	2,4 W/ (m ² · K)	NPD	NPD
	PA		Liscio + pantografato	Classe 4	34 dB	2,2 W/ (m ² · K)	NPD	NPD
	PA	6x16	Liscio + pantografato 6X16	Classe 4	34 dB	1,8 W/ (m ² · K)	NPD	NPD
	PA		Liscio CCE + pantografato	Classe 4	34 dB	2,2 W/ (m ² · K)	NPD	NPD
	PA	6x16	Liscio CCE + pantografato 6X16	Classe 4	34 dB	1,8 W/ (m ² · K)	NPD	NPD
	PABASV		Liscio + pantografato + soglia svizzera	Classe 4	34 dB	2,2 W/ (m ² · K)	NPD	NPD
	BASV	6x16	Liscio + pantografato 6X16 + soglia svizzera	Classe 4	34 dB	1,8 W/ (m ² · K)	NPD	NPD
	SOPA		Liscio + pantografato + sopraluce	NPD	NPD	2,4 W/ (m ² · K)	NPD	NPD
	SOPA	6x16	Liscio + pantografato 6X16 + sopraluce	NPD	NPD	2,4 W/ (m ² · K)	NPD	NPD
	PAPA		Pant + pant	Classe 4	34 dB	2,5 W/ (m ² · K)	NPD	NPD
	PAPA	6x16	Pant + pant 6X16	Classe 4	34 dB	1,8 W/ (m ² · K)	NPD	NPD

Famiglia Model Modelo	Accessori Optionals Accesorios	Cod.agg. Code Codigo	Descrizione Description Descripción	Effrazione Anti Burglary Efracción UNI ENV-1627 1628 - 1630	Acustica Acoustic Acustico ISO 717 ISO 140	Termica Thermic Termico UNI EN 10077-1-2	Aria-Acqua-Vento Air-Water-Wind Aire-Agua-Viento EN 1026 - 1027 12211	Fuoco Fire Fuego UNI 9723 1634 ARRETE 03/08/09
	PAPABASV		Pant + Pant + soglia svizzera	Classe 4	34 dB	2,5 W/ (m ² · K)	NPD	NPD
	PAPABA	6x16	Pant + Pant 6X16 + soglia svizzera	Classe 4	34 dB	1,8 W/ (m ² · K)	NPD	NPD
	SOPAPA		Pant + pant + sopra luce	NPD	NPD	2,6 W/ (m ² · K)	NPD	NPD
	SOPAPA	6x16	Pant + pant 6X16 + sopra luce	NPD	NPD	2,4 W/ (m ² · K)	NPD	NPD
	SOPAPAFI		Pant + pant + sopra luce + finestrata	NPD	NPD	2,8 W/ (m ² · K)	NPD	NPD
		40 dB	Liscio + liscio + kit 40 dB	Classe 4	40 dB	1,9 W/ (m ² · K)	NPD	NPD
		40 dB	Liscio CCE + liscio CCE	Classe 4	40 dB	1,9 W/ (m ² · K)	NPD	NPD
	PA	40 dB	Liscio + pantografato + kit 40 dB	Classe 4	40 dB	2,3 W/ (m ² · K)	NPD	NPD
	PA	40 dB 6x16	Liscio + pantografato 6X16 + kit 40 dB	Classe 4	40 dB	1,9 W/ (m ² · K)	NPD	NPD
	PA	40 dB	Liscio CCE + pantografato + Kit 40 dB	Classe 4	40 dB	2,3 W/ (m ² · K)	NPD	NPD
	PA	40 dB 6x16	Liscio CCE + pantografato 6X16 + Kit 40 dB	Classe 4	40 dB	1,9 W/ (m ² · K)	NPD	NPD
	PAPA	40 dB	Pant + Pant + kit 40 dB	Classe 4	40 dB	2,6 W/ (m ² · K)	NPD	NPD
	PAPA	40 dB 6x16	Pant + Pant 6X16 + kit 40 dB	Classe 4	40 dB	1,9 W/ (m ² · K)	NPD	NPD
	SO	40 dB	Liscio + liscio + kit 40 dB + sopra luce	NPD	40 dB	2,5 W/ (m ² · K)	NPD	NPD
	SOPA	40 dB	Liscio + Pant + kit 40 dB + sopra luce	NPD	40 dB	2,5 W/ (m ² · K)	NPD	NPD
	SOPA	40 dB 6x16	Liscio + Pant 6X16+ kit 40 dB + sopra luce	NPD	40 dB	2,5 W/ (m ² · K)	NPD	NPD
	SOPAPA	40 dB	Pant + Pant + kit 40 dB + sopra luce	NPD	40 dB	2,7 W/ (m ² · K)	NPD	NPD
	SOPAPA	40 dB 6x16	Pant + Pant 6X16 + kit 40 dB + sopra luce	NPD	40 dB	1,9 W/ (m ² · K)	NPD	NPD
MAGMA-C				NPD	34 dB	2,2 W/ (m ² · K)	NPD	REI 60
			38 dB con para aria acustico	NPD	38 dB	2,2 W/ (m ² · K)	NPD	REI 60
			40 dB (Porta fornita con doppio para aria)	NPD	40 dB	2,2 W/ (m ² · K)	NPD	REI 60
			42dB (Porta fornita con soglia svizzera a pavimento)	NPD	42 dB	2,2 W/ (m ² · K)	NPD	REI 60
MAGMA EI1-30				NPD	35 dB	2,0 W/ (m ² · K)	NPD	EI1-30
MAGMA EI2-30			con para aria standard	NPD	35 dB	2,0 W/ (m ² · K)	NPD	EI2-30
			con para aria acustico	NPD	42 dB	2,0 W/ (m ² · K)	NPD	EI2-30
WALL EI2-60				NPD	36 dB 39 dB	1,6 W/ (m ² · K)	NPD	EI2-60

Famiglia Model Modelo	Accessori Optionals Accesorios	Cod.agg. Code Codigo	Descrizione Description Descripción	Effrazione Anti Burglary Efracción UNI ENV-1627 1628 - 1630	Acustica Acoustic Acustico ISO 717 ISO 140	Termica Thermic Termico UNI EN 10077-1-2	Aria-Acqua-Vento Air-Water-Wind Aire-Agua-Viento EN 1026 - 1027 12211	Fuoco Fire Fuego UNI 9723 1634 ARRETE 03/08/09
VOLTA C				NPD	34 dB	1,3 W/ (m ² · K)	NPD	NPD
VOLTA DUO/C				NPD	31 dB	1,5 W/ (m ² · K)	NPD	NPD
WALL	SILVER1 GOLD	WA		Classe 3	36 dB	1,0 W/ (m ² · K)	2-NPD-C2	NPD
			40 dB (porta fornita con kit 40 dB)	Classe 3	39 dB	1,1 W/ (m ² · K)	2-NPD-C2	NPD
	PLATINUM TITANIUM			Classe 4	34 dB	1,8 W/ (m ² · K)	NPD	NPD
WING	SILVER1	WI		Classe 3	36 dB	1,0 W/ (m ² · K)	2-NPD-C2	
SILVER-GOLD			CON KIT DI RIVESTIMENTO FLAT	Classe 3	39 dB	1,0 W/ (m ² · K)	NPD	NPD
PLATINUM TITANIUM			CON KIT DI RIVESTIMENTO FLAT	Classe 4	39 dB	1,4 W/ (m ² · K)	NPD	NPD

NOTA - LE PRESTAZIONI INDICATE POTRANNO, NEL CORSO DELL'ANNO, SUBIRE VARIAZIONI SIGNIFICATIVE A CAUSA DI MIGLIORAMENTI PRESTAZIONALI E PARTICOLARI CONFIGURAZIONI RICHIESTE DAI CLIENTI.

The performances indicated could be improved during the year due to better performances and particular requests of the customer.

A lo largo del año, las prestaciones indicadas podrán tener cambios significativos causados por las mejoras prestacionales y las especiales configuraciones que el cliente solicite.

PA	Presenza di un rivestimento pantografato (o interno o esterno) Pantographed panel (internal or external) Hay un tablero de madera cruzada (adentro o afuera)	A54B	Kit aria + acqua + vento Air-Water-Wind Kit aire-agua-viento
6x16	Presenza di rivestimento pantografato con battute perimetrali - a sporgere - 6x16 - pantographed panel with lateral working - leaning out 6x16 tableros pantografiados resaltantes	39 dB	Kit 40 dB per porte con sopra-luce 40dB kit for glass transom door Kit 40 dB para puertas con lumbrera
SO	Presenza di sopra-luce Glass Transom - Hay una lumbrera	40 dB	Kit 40 dB per porte senza sopra-luce 40 dB kit for door without glass transom Kit 40 dB para puertas sin lumbrera
SV	Presenza soglia svizzera Swiss sill - umbral fixo	42 dB	Kit 42 dB per porte senza sopra-luce 42 dB for door without glass transom Kit 42 dB para puertas sin lumbrera
PAPASV	Presenza di liscio + pantografato + soglia svizzera Flat + pantographed panel + Swiss sill Tablero liso + pantografiado + umbral fixo	44 dB	Kit 44 dB per porte senza sopra-luce 44 dB for door without glass transom Kit 44 dB para puertas sin lumbrera
PAPA	Presenza di pantografato all'interno e all'esterno Pantographed panel (internal and external) Hay un tablero de madera cruzada adentro y afuera	Dove non indicato si fa riferimento a pannelli int. est. lisci 6 mm 34 dB se non diversamente specificato.	
SOPA	Presenza di sopra-luce e n° 01 pantografato (o interno o esterno) Glass Transom and pantographed panel (internal or external) Hay una lumbrera y un tablero de madera cruzada (adentro o afuera)	If not indicated, we refer to flat internal and external panel 6 mm thick 34 dB if not indicated differently.	
SOPAPA	Presenza di sopra-luce e pantografato all'interno e all'esterno Glass Transom pantographed panel (internal and external) Hay una lumbrera y un tablero de madera cruzada (adentro o afuera)	Si no indicado diversamente se intenden tableros lisos internos y externos 6 mm 34 dB si no es indicado diversamente.	
PAPAFI	Porta finestrata Glass Door - Puerta con vidrio	I COLORI E LE ESSENZE DEI PANNELLI RIPRODOTTI SU QUESTO CATALOGO SONO INDICATIVI E IN NESSUN MODO VINCOLANTI PER ALIAS.	
PAPAFIFI	Porta con doppia finestrazione (anta + antino) Double Glass door (leaf + small leaf) Puerta con vidrio en las dos hojas	The colors and the essence of the panels that have been reproduced in this catalogue are indicative and they are in no way an obligation for Alias.	
		Los colores y tipos de maderas de los paneles ilustrados en este catálogo son indicativos, y en ningún modo supondrán compromiso por parte de Alias.	

CONDIZIONI GENERALI DI VENDITA

• **OGGETTO DEL CONTRATTO:** Offerte, commissioni, conferme: il presente contratto viene di comune accordo considerato vendita in ogni sua parte e, come tale, assoggettato alla relativa disciplina legale anche quando comprende la posa in opera di prodotti acquistati e relativi servizi. Le offerte degli agenti e operatori di ALIAS, anche se fatte per iscritto sono soltanto dimostrative e non sono mai per essa impegnative; lo diventano solo quando, fatte proprie dal cliente per iscritto mediante sottoscrizione della conferma d'ordine (foglio commissione), la sede ALIAS abbia successivamente spedito al cliente il suo consenso scritto (conferma d'ordine) alla stipulazione del relativo contratto. Il cliente sottoscrivendo la conferma d'ordine pone in essere l'effettiva proposta che si obbliga a non revocare per almeno 7 giorni lavorativi. La sede ALIAS è libera di accettare o meno l'eventuale proposta di revoca. Qualora, eccezionalmente, la sede ALIAS consentisse la revoca della commissione entro la suddetta scadenza, essa avrà diritto ad una penale per spese tecnico-commerciali, comunque fatte o in corso, nella misura del 15% sulla somma risultante in commissione. Qualora il cliente, successivamente alla sottoscrizione della conferma d'ordine contenente la specifica dei prodotti ordinati, richiedesse la modifica di tali prodotti, dovrà comunicarlo entro 7 giorni lavorativi in forma scritta alla Venditrice che si riserva il diritto di comunicare, a sua volta, nuovi, eventuali, termini di consegna ed eventuali maggiori oneri che la modifica e, conseguentemente, la stessa consegna possa comportare. Eventuali ordini successivi a completamento saranno comunque soggetti alle condizioni dell'ordine principale o del listino prezzi in vigore ed i prezzi saranno di volta in volta riveduti anche in considerazione della frammentarietà degli ordini e del tempo trascorso dalla sottoscrizione del foglio commissione relativo all'ordine principale.

• **PREZZI:** se si verificano aumenti a) dei costi di mano d'opera e/o b) del costo dei materiali e/o c) del costo dei servizi oggetto della fornitura la Venditrice avrà diritto di aggiornare corrispondentemente i prezzi secondo gli aumenti intervenuti fra la data della commissione d'ordine e la data in cui vengono ultimate le consegne dei materiali o le operazioni di posa in opera, anche se avvenute in ritardo. Gli aggiornamenti dei prezzi verranno applicati indipendentemente dagli acconti ricevuti e verranno addebitati con fattura pagabile come da condizioni di contratto.

• **PAGAMENTI:** è obbligo inderogabile dell'Acquirente effettuarli direttamente alla sede ALIAS e ciò vale anche se nelle condizioni particolari sono stati pattuiti o di fatto adottati il sistema di pagamento a mezzo tratte accettate, a mezzo cambiali, assegni, ricevute bancarie o simili. In caso di pagamento con effetti cambiari e/o assegni i titoli di credito dovranno essere intestati alla Venditrice ed essere completi di ogni requisito di legge; in difetto, l'Acquirente autorizza la venditrice a riempire il titolo incompleto successivamente con i dati mancanti conformemente alle condizioni particolari e generali del contratto di compravendita. Il rilascio di effetti cambiari si considera sempre "pro solvendo" e gli eventuali rinnovi non costituiscono mai novazione delle originali obbligazioni contrattuali. Nessuno di di fuori della sede ALIAS è autorizzato a ricevere pagamenti salvo il caso in cui sia munito di speciale procura ad hoc. Gli interessati sulle somme dovute a titoli di prezzo oppure di anticipazioni di imposte a carico del cliente, sia sugli acconti che sui pagamenti frazionati o rateali, che sui saldi, sono determinati in base al tasso pattuito nella misura indicata nelle condizioni particolari di pagamento. In mancanza di tale indicazione gli interessi si intendono pattuiti in misura pari al tasso ufficiale di sconto della Banca d'Italia all'atto della commissione maggiorato del 50%. Ogni pagamento ritardato sarà imputato prima in conto interessi scaduti poi a capitale. L'inadempienza anche parziale ai puntuali pagamenti così come l'insolvenza dell'Acquirente evidenziata da cessioni di beni, da protesti di assegni o cambiali o da aperture di procedure concorsuali nei suoi confronti da diritto ad ALIAS di sospendere la fornitura, anche se già in corso, e, anche, di risolvere immediatamente il contratto, chiedendo modalità e tempi più restrittivi di pagamento anche dopo il versamento di acconti o rilascio di effetti con totale esonero di risarcimento danni per la Venditrice. Nessuna eccezione o contestazione dell'Acquirente gli dà diritto di sospendere in tutto o in parte i pagamenti.

• **DECADENZA BENEFICIO DEL TERMINE:** In caso di pagamenti rateali il mancato pagamento anche di una sola rata provoca l'immediata scadenza delle successive con decadenza dell'Acquirente del beneficio del termine, anche se per ordini diversi e/o consegne ripartite.

• **CONSEGNA:** i termini che sono esclusivamente quelli indicati nella conferma dell'ordine non sono mai impegnativi per ALIAS, ma sono sempre soltanto approssimativi; essi decorrono in ogni caso non dalla data della commissione, ma dalla data della conferma d'ordine da parte di ALIAS e, se successiva, dalla data di ultimo arrivo alla sede ALIAS dei dati, progetti, elaborati, specifiche o elementi utili e comunque definitivi per l'esecuzione del contratto. Ogni termine per ALIAS è convenuto anche con la clausola del salvo imprevisi di lavorazione, scioperi, avversità atmosferiche, cause fortuite o di forza maggiore. L'adempimento dei termini di consegna dei prodotti da parte di ALIAS si conviene che è assolto allorché essa li abbia pronti in stabilimento per l'epoca convenuta, qualunque sia il posto pattuito per la consegna. Per luogo di consegna si stabilisce inderogabilmente lo stabilimento di produzione: ogni pattuizione di consegna in ogni altro luogo e relative forme e operazioni e gli ulteriori servizi e prestazioni, si intendono essere obbligazioni accessorie al contratto fondamentale di compravendita. Trascorsi i termini di consegna senza il ritiro della merce da parte dell'Acquirente, ALIAS ha il diritto di procedere ai sensi dell'articolo seguente. Per i materiali così a disposizione dell'Acquirente ogni eventuale posticipazione di data di consegna deve essere da lui richiesta alla sede ALIAS per iscritto almeno 30 giorni prima della data prefissata; in ogni caso ALIAS ha il diritto di stabilire nuovi termini di consegna oppure di rifiutare il differimento dei termini con la risoluzione automatica delle successive eventuali obbligazioni di contratto.

• **RTIRATO NEL RITIRO DEI PRODOTTI:** trascorsi 15 giorni dalla data prevista per la consegna senza che l'Acquirente abbia ottemperato ai suoi obblighi entro i termini pattuiti, anche se non ritira, i prodotti stessi si intendono, con la scadenza di tale data, consegnati a tutti gli effetti, anche contrattuali e del pagamento, nonché della responsabilità e del rischio e così anche del deterioramento che è danno dell'Acquirente il quale, dalla data stessa, è obbligato a pagare, inoltre, ad ALIAS un indennizzo per spese di immagazzinaggio pari ad Euro 10/pezzo/mese.

• **POSA IN OPERA:** quando previsto nel contratto a carico di ALIAS deve intendersi prestazione accessoria al contratto di vendita dei prodotti e, in quanto tale, la committente riconosce che non costituisce appalto. Deve essere richiesta non oltre due mesi dalla data di consegna della merce e si svolge compatibilmente alla disponibilità della mano d'opera da parte della Venditrice al momento della richiesta senza responsabilità per essa per eventuali ritardi. Se la posa in opera dovesse essere interrotta dall'Acquirente per qualsiasi ragione sarà poi ripresa con tempi e costi da concordare e qualora l'Acquirente pur avendo richiesto la posa in opera per motivi di cui sopra o per accelerare il lavoro, dovesse ricorrere ad altro personale, previo accordo scritto con la Venditrice, alla stessa non verranno esposti gli oneri di posa in opera come previsti nel contratto e null'altro. La posa in opera e le opere murarie ad essa legate sono essenziali per il buon funzionamento del prodotto e per l'ottenimento delle prestazioni dichiarate. ALIAS farà decadere tutte le garanzie legali sul prodotto in caso di posa eseguita dall'Acquirente direttamente o in subappalto in modo difforme da quanto indicato dalle istruzioni di prodotto o in generale dalla buona norma tecnica di prodotto. Ultimata la posa in opera eseguita da mano d'opera della Venditrice, l'Acquirente deve rilasciare il benessere alla squadra di posa onde facilitare alla Venditrice il controllo del lavoro eseguito. In caso di mancato rilascio del benessere di posa in opera la fornitura si intende accettata senza riserve dall'Acquirente. In ogni caso l'abilitazione dell'immobile o la consegna dello stesso a terzi viene espressamente considerata dalla Venditrice e dall'Acquirente incondizionata accettazione della fornitura con l'esenzione per la Venditrice di qualsiasi ulteriore onere.

• **GARANZIA:** il committente accorda alla Venditrice tutte le tolleranze d'uso sulle dimensioni e sulle tipologie accessorie. Nel caso la merce non potesse essere utilizzata per difetti di materiale o altro imputabile alla Venditrice, e che questa riconosca, essa ha la facoltà o di sostituirla o di effettuare le possibili riparazioni oppure di rimborsarne il relativo prezzo con esclusione per l'Acquirente di pretendere indennizzi di qualsiasi genere neppure per il ritardo per mano d'opera, per trasporto o altro. Non sono validi quei reclami effettuati con modalità diverse da quelle specificate nell'articolo seguente. L'eventuale accredito ha corso solo dopo che alla Venditrice è stata restituita la merce contestata, così pure per la sostituzione. L'Acquirente dichiara a tutti gli effetti di aver visionato il campione di prodotti ordinati, dandone specifica approvazione.

• **RECLAMI E DIRITTO DI RECESSO:** per qualsiasi genere e causa per essere validi devono essere fatti a mezzo lettera raccomandata direttamente ad ALIAS s.r.l. con sede legale e operativa in Via Berlinguer, 22 - Settima di Gossolengo (PC) entro il termine perentorio di 10 giorni lavorativi dall'arrivo della merce ordinata.

• **SPEDIZIONE E TRASPORTI:** come accessorio al contratto di compravendita potrà essere pattuita tra ALIAS e l'Acquirente la spedizione a mezzo ferrovia o corriere oppure automezzo dell'ALIAS o da questa in qualunque modo fornito. In questo caso resta inteso che la compravendita è indipendente dalla pattuizione di cui sopra ed è già esaurita al momento della merce pronta in stabilimento. Resta inteso che le obbligazioni della ALIAS relative alla conservazione e tempi di consegna per il trasporto della merce, si esauriscono al momento del carico sui messi forniti dall'Acquirente, o in nome e per conto dell'Acquirente, per il prelievo e il trasporto, ovvero alla consegna alla ferrovia o al corriere per l'esecuzione del trasporto. Se la consegna è a mezzo autotreno non inviato dall'Acquirente, il trasporto viene effettuato sin dove la strada è facilmente accessibile al mezzo impiegato. Nessuna responsabilità per fatti o ritardi inerenti a spedizioni a mezzo ferrovia, corrieri, automezzi inviati dall'Acquirente o agenti a suo nome e conto, potrà essere addebitato ad ALIAS. Per i trasporti a mezzo veicoli ALIAS o da essa in qualunque modo forniti si intende che fine l'accettazione della presente clausola sta per delega ad ALIAS da parte dell'Acquirente al compimento delle predette operazioni. I materiali di imballo in legno, gomma ed altro, devono essere restituiti alla ALIAS franco stabilimento di provenienza, o, in difetto, saranno fatturati all'Acquirente. In mancanza di precisi accordi per imballaggi particolari la Venditrice provvederà come da propria prassi e così l'imballaggio si intenderà eseguito a regola d'arte qualora accettato senza riserve da parte del vettore. La merce viaggia sempre per conto, rischio e pericolo del committente anche se convenuta resa franco destino.

• **RISERVA DI PROPRIETÀ:** la proprietà della merce è riservata alla Venditrice con espresso divieto all'Acquirente di alienarla prima del completo pagamento. La merce potrà essere rivendicata dalla Venditrice ovunque essa si trovi. Il mancato pagamento anche di una sola rata determina la risoluzione di diritto del contratto. I versamenti effettuati vanno integralmente a beneficio della Venditrice a titolo di indennità, salvo maggiori danni e ciò in deroga all'art.1525 c.c.. Agli effetti di quanto sopra per ogni responsabilità conseguente, la Venditrice è autorizzata a portare a conoscenza dell'eventuale proprietario dell'immobile o terzo o comunque interessato il contratto ed il patto di riservato dominio.

• **COMPETENZA GIUDIZIARIA:** per qualsiasi controversia derivate dal presente contratto, nonché dalla sua interpretazione ed esecuzione, sarà esclusivamente competente l'autorità giudiziaria di Piacenza; ciò anche se il pagamento sia convenuto a mezzo cambiali domiciliati presso il debitore. Tale competenza non può essere derogata neppure per ragioni di connessione, comunione o garanzia.

• **INFORMATIVA AI SENSI DELL'ART. 13 del D.Lgs. 30.06.2003 n. 196.**
Ai sensi dell'art. 13 del D.Lgs. 196/2003, ALIAS s.r.l. con sede legale e operativa in Via Berlinguer, 22 Settima di Gossolengo PC, Titolare del trattamento dei dati, La informa che: i dati raccolti da ALIAS srl saranno trattati elettronicamente per l'evasione degli Ordini e per finalità connesse, nonché ai fini di elaborazione statistica e per iniziative promozionali e di marketing. La natura del conferimento dei dati è facoltativa. I dati sono comunque necessari per l'adempimento dell'incarico richiesto dall'interessato, e senza di essi sarà impossibile svolgere alcuna attività a favore del richiedente. L'accesso ai dati è consentito ai soggetti specificatamente incaricati quali dipendenti, consulenti, terzi fornitori di servizi per le finalità su indicate ovvero potranno essere comunicati all'esterno nell'ambito di società controllanti e controllate. Inoltre come previsto dagli articoli 7, 8, 9, 10 del D.Lgs. n. 196/2003, ogni interessato può richiedere in qualsiasi momento la conferma dell'esistenza, la modifica o la cancellazione dei propri dati, scrivendo al Responsabile Ufficio Clienti presso ALIAS.

GENERAL SALES CONDITIONS

• **CONTRACT OBJECT - OFFERS, COMMISSIONS, ORDER CONFIRMATION:** As agreed by the parties, the following contract is considered a sales contract in all its parts and for this reason it is subjected to the related legal rules even when it includes the set up and the related services. The offers of the sales agents and ALIAS personals, even in a written form, are only made for demonstrative scopes. They become obligations when the customers accept them signing the order confirmation (commission sheet) and after that ALIAS premises has sent to the customer its written approval (order confirmation) of the drawing up of the agreement. The customer, signing the order confirmation, puts in place the real proposal and he is engaged not to withdraw it for at least 7 working days. ALIAS's premises is free to accept or not the eventual withdraw proposal. If ALIAS premises would consent in an exceptional manner to the withdraw of the proposal within the above deadline, ALIAS will have to right to ask for a penalty for the incurred or current technical-commercial expenses of the value of 15% of the amount that comes from the commission. If the customer, after the order confirmation's signature that contains the ordered products features, would ask for a modification, he should communicate it within 7 workings days in written form to ALIAS's premises which reserves the right to communicate eventual news delivery times and eventual prices increase. Eventual further completion orders will be subjected to the same conditions of the main order and or to the current price list and the prices could be revised due to the orders fragmentary and spent time from the main order.

• **PRICES:** If increases of workforces' costs and/or material costs and/or costs of the services included in the orders occur, ALIAS has the right to update the prices according to the increases occurred between the commission's date and the delivery of material or the setup' date, even if with delay. The price revisions will be applied independently from the advance payments and it will be charged with invoice as per contract conditions.

• **PAYMENTS:** The Buyers has to carry out all the payments directly to ALIAS's premises and even if particular conditions have been agreed such as drafts, bill of exchanges, checks or cash orders and similar. If these kind of payments have been agreed, the drafts should be issued on behalf of ALIAS and it should be filled in according to law dispositions, in case of incomplete draft, the buyer authorizes the seller to fill in the draft with all the missing data according to the particular conditions of the sales contract. The issue of bills of exchange is always considered "pro solvendo" and eventual renewals are never a novation of the original contract obligations. No one outside ALIAS's premises is authorized to receive payments except a special attorney. The interests of the sums that comes from drafts, or from clients advanced payments taxes, or partial payment or installment payment or balance, are fixed according to the agreed rate indicated in the sales contract. If there is not a specific indication, the interests are fixed according to the official discount rate established by Banca di Italia at the time of commission, increased of 50%. Each delayed payments will be charged first to interests account then to capital. The default, even partial, of the payments along with the insolvency of the buyer demonstrated by real estate transfers, protest of a bill or bankruptcy proceedings, allows ALIAS to suspend the supply, even if it is already in due course and also to withdraw the contract immediately, asking for more restrictive terms of payments even after advanced payments or drafts issues with entire exemption from damages payments for the Sellers. No exceptions or contestations of the buyers allow to suspend partially or entirely the payments.

• **EXTINCTION TERM'S BENEFIT:** In case of installment payments, the nonpayment of even a single rate causes the immediate expiry of the other rates with the extinction for the buyer of the terms benefit, even for different orders and/or split delivery.

• **DELIVERY:** The terms are exclusively indicated in the order confirmation and they are never binding for ALIAS, but they are approximate. They become effective not from the commission date, but from the signature of the order confirmation issued by ALIAS and, if following, from the date of the last arrival to ALIAS premises of information, projects, requirements and all the useful and definitive elements to carry out the contract. Each terms for ALIAS is agreed with the clause of unless unforeseen of workings, strikes, weather adversity, accidental causes, or force majeure. The fulfillment of the delivery terms of the products is effective for ALIAS when the product are ready to load at the agreed date, whatever it is the delivery address. As delivery address it is established without exception the manufacturing plant: every different agreement about the delivery and the related forms and necessary operations and services are accessory obligations to the main sales contract. Expired the delivery terms without the goods collecting by the buyer, ALIAS has the right to proceed as per the following article. So, for the available goods for the buyer, every slipping of the delivery date should be communicated by written form to ALIAS premises at least 30 days before the agreed date. Nevertheless, ALIAS has the right to fix new delivery terms or to refuse the slipping of the delivery date with the automatic withdrawing of latter contract obligations.

• **DELAY IN THE GOODS COLLECTING:** After 15 days from the fixed delivery date, if the buyer hasn't fulfilled to his obligations within the agreed deadlines, even if he doesn't collect the goods, the products are to be considered as effectively delivered also from contractual, payment, risk, responsibility and deterioration of the goods point of view. Moreover, the buyer should pay to ALIAS an indemnity for stock expenses of 10€/piece/month.

• **SETUP:** If the set up requested to ALIAS is included in the contract, it is an accessory service to the sales contract and therefore the buyer acknowledges that it is not a tender. It should be requested within 2 months from the delivery date and it will be carried out according to the workforce's availability at the moment of the request without the responsibility for any delay. If the setup is suspended by the buyer for any reasons, it will be restarted with revised prices and terms. If the buyer, despite it has requested the setup, for reasons as above or to speed-up the job, would use other personnel, prior written consent of the seller, no setup costs will be charged, as agreed in the contract. The set up and the related works walls are essential for a proper functionality of the product and to ensure the declared performances. ALIAS will let decay all the legal warranties of the product if the set up carried out by the buyer doesn't comply with the product instructions or

generally speaking with good technical standards. Once the setup is finished by the Seller personnel, the buyer should release his approval to let Seller check the done job. If no approval is released, the supply is considered as fully accepted by the buyer. However, the habitability of the property or its delivery to a third party is considered expressively by the seller and by the buyer as unconditional approval of supply with the exemption for the seller of any further obligations.

• **WARRANTY:** The buyer accords to the seller all the use allowances of dimensions and accessories. If the goods could not be used for material defects or for any other reasons to be ascribed to the sellers acknowledged by the seller, the seller has right to replace the goods or to carry out the possible fixings or to reimburse its price with the exception for the buyer to claim anything else nor for the workforce or transports. The claims that don't comply the procedures illustrates in the above article are not valid. The eventual credit can be executed only after that the rejected goods have been given back to the sellers and also for the replacement. The Buyer declares to have inspected the sample of the ordered products, approving it expressively.

• **CLAIMS AND RIGHT TO WITHDRAW:** For any reasons, the claims should be done by record letter address to ALIAS s.r.l. with legal premises in Via Berlinguer 22 - Settima di Gossolengo (PC) within the deadline of 10 workings days from the arrival of goods.

• **DELIVERY AND TRANSPORTS:** As accessory the sales contract, the transport of good could be agreed between ALIAS and the buyer. The transport could be carried out by train, courier or by ALIAS vehicle. In this case, the sale is independent from the agreement about the transport and it is run out as long as the goods are ready ex works. It is understood that the obligations for ALIAS that concern the storage and the delivery times of the goods transport are fulfilled when the goods are loaded up to means supplied by the buyer or on behalf of the buyer or when the goods are delivered to train or to the courier for the transport execution. If the delivery is carried out by a vehicle not sent by the buyer, the transport will be done till the road will be accessible. No responsibility for delays or any other issues related to transport by train, couriers, vehicles or agents sent by the buyer or on behalf of the buyer could be charged to ALIAS. For transports carried out by ALIAS means or generally supplied by ALIAS, it is understood that the approval of this clause is a proxy to ALIAS from the buyer to carry out these operations. The wood or rubber packages should be given back to ALIAS ex works or if not given back the packages will be invoiced. If there aren't detailed agreements about packages, the Seller will go ahead with the usual packages therefore it will be understood that they are made workmanlike if the buyer accepts them without reserves the package. The goods travel always at buyer risk's even if the goods are FOB.

• **PROPERTY RESERVE:** The goods property is reserved to the Seller with the express prohibition for the Buyer to give them away before the complete payment. The goods could be claimed by the Seller no matter where they are. The missed payment of even only a rate causes the contract withdraw. The payments on behalf of the Seller are to be considered as indemnity, unless greater damages in derogation to art. 1525 c.c. All this provided and for all the concerned responsibilities, the seller is authorized to let the final owner of the property or the third parties know the conditional right of domain.

• **LEGAL JURISDICTION:** For all the disputes arisen from this contract and its interpretation and execution, the only authority that has jurisdiction is Piacenza court, even though the agreed payments are drafts located at premises loaner. This jurisdiction can't be derogated not even for reasons of concession, guaranties or communions.

• **INFORMATIVE ACCORDING TO ART 13. D.LGS 30.06.2003 N.196.**

According to art. 13 D.lgs. 196/2003, ALIAS s.r.l. with legal premises in Via Berlinguer 22 Settima di Gossolengo PC, Legal owner of data treatment, informs that: data collected by ALIAS will be treated in an electronic way for orders execution and connected scopes, for statistis elaboration and for promotional and marketing scopes. The essence of the given information is facultative. The data are however necessary for the execution of the requested tasks and without them it is impossible to carry out any requested activity. Data access is allowed to clearly indicated subjects such as dependents, consultants, services of suppliers for the indicated scopes or they could be communicated to related companies. Moreover, as per art. 7,8,9,10 D.Lgs n. 196/2003, everyone who may be concerned can ask for, in every moment, the confirm of the existence, the modification or the cancellation of his own data, writing to Chief Customer Office in ALIAS.

CONDICIONES GENERALES DE VENTA

• **OBJETO DEL CONTRATO:** Ofertas, pedidos y confirmaciones. Este contrato, por acuerdo mutuo, se considera de venta en todas y cada una de las partes que lo forman; por lo cual, está sujeto a la correspondiente disciplina legal, incluso cuando incluye la puesta en obra de artículos comprados y sus respectivos servicios. Las ofertas que efectúen agentes comerciales u operadores de ALIAS, aunque estén por escrito, son solamente demostrativas y nunca, por sí solas, suponen compromiso, volviéndose tal en el momento en que el cliente acepte y firme la confirmación de pedido (hoja de comisión) y la sede de ALIAS envíe, sucesivamente, al cliente y por escrito (confirmación de pedido) el consentimiento para estipular el correspondiente contrato. El cliente, al firmar la confirmación de pedido, activa, pues, la efectiva propuesta, con la obligación de no revocarla durante 7 días laborales, por lo menos. La sede de ALIAS se considera libre de aceptar o no aceptar la eventual propuesta de revocación. En caso de que, excepcionalmente, la sede de ALIAS admitiera la revocación del pedido en el plazo citado, tendrá derecho a cobrar una penalidad por los gastos técnico-comerciales ya efectuados o que estuvieran en curso, correspondiente al 15% de la cantidad indicada en el pedido. En caso de que el cliente, tras haber firmado la confirmación del pedido que contiene la especificación de los artículos pedidos, quisiera solicitar la modificación del listado de tales artículos, lo deberá comunicar por escrito, en el plazo de 7 días laborales, al Vendedor, el cual se reserva el derecho de comunicar, a su vez, nuevos y eventuales plazos de entrega y eventuales aumentos de los gastos que la modificación y, por consiguiente, la misma entrega pudiera conllevar. Aquellos pedidos que se efectuaran sucesivamente como terminación del principal, estarán sujetos a las condiciones del pedido principal, o de la lista de precios en vigor, y los precios podrán modificarse, según la fragmentariedad de los pedidos y del tiempo que haya transcurrido desde el momento de la firma de la hoja de pedido relativa al pedido principal.

• **PRECIOS:** si se verificaran aumentos a) de los costes de la mano de obra y e/o b) del coste de los materiales y/o c) del coste de los servicios objeto del suministro, el Vendedor tendrá derecho a actualizar adecuadamente los precios, según los aumentos que se hayan dado entre la fecha del pedido y la fecha en la que tienen lugar la entrega de los materiales y las intervenciones de puesta en obra, aunque tengan lugar con retraso. Las actualizaciones de los precios se aplicarán independientemente de los anticipos depositados, y se adecuarán con factura pagadera, tal y como se indica en las condiciones del contrato.

• **PAGOS:** El Comprador tiene la obligación inderogable de efectuar el pago directamente dirigiéndolo a la sede de ALIAS, lo cual vale también si se hubieran convenido condiciones particulares de pago, o si se hubiera adoptado un sistema de pago a plazos, por letras, cheques, justificantes bancarios o similares. En caso de pago mediante letras de cambio o efectos de comercio y/o cheques, los valores de crédito deberán estar a nombre del Vendedor y con todos los requisitos de la ley cumplidos y los datos rellenados; en su defecto, el Comprador autoriza al Vendedor a rellenar el valor incompleto sucesivamente, con los datos que falten, en conformidad con las condiciones particulares y generales del contrato de compraventa. Librar letras de cambio se considera siempre "pro solvendo", y aquellas eventuales reconducciones no constituyen novación de las obligaciones contractuales de origen. Nadie, además de la sede ALIAS, está autorizado a cobrar cantidades, a no ser que esté facultado para ello mediante poder especial. Los intereses sobre las cantidades debidas en concepto de precio, o de anticipación de impuestos a cargo del cliente, tanto de los anticipos que de los pagos por plazos, como de los saldos están determinados según el tipo pactado en el valor indicado en las condiciones particulares de pago. En defecto de tal indicación los intereses se entienden establecidos en lo correspondiente al tipo oficial de descuento de la entidad bancaria Banca d'Italia en el acto del pedido aumentado del 50%. Todos los pagos que se efectuaran con retraso serán imputados primero en la cuenta de intereses vencidos y después en capital. El incumplimiento, incluso parcial, de los pagos puntuales establecidos, así como la insolvencia del Comprador que se diere y se señalara por cesión de bienes, protestos de cheques o de letras o por aperturas de procedimientos concursales respecto a éste, le da el derecho a ALIAS de suspender el suministro de material, incluso si éste fuera en curso, y también de resolver inmediatamente el contrato, pudiendo pedir modos y tiempos más restrictivos de pago incluso si se hubieran depositado anticipos o se hubieran librado efectos, con total exoneración del Vendedor de pago por daños. Ninguna excepción o contestación del Comprador le da al mismo el derecho de suspender total o parcialmente los pagos.

• **VENCIMIENTO DEL BENEFICIO DEL PLAZO:** En caso de pago a plazos, en defecto del pago de un plazo provoca inmediato vencimiento de los sucesivos, con la decadencia del beneficio del plazo del Comprador, incluso en caso de pedidos diferentes y/o entregas repartidas.

• **ENTREGA:** los términos, que son exclusivamente los indicados en la confirmación de pedido, no suponen compromiso para ALIAS, sino que son siempre y sólo aproximados; éstos se calculan, en todo caso, no desde la fecha de pedido, sino desde la fecha de la confirmación de pedido por parte de ALIAS y, si es sucesiva, desde la fecha última en la que lleguen a la sede ALIAS los datos, proyectos, documentos escritos, especificaciones o elementos útiles y definitivos para la ejecución del contrato. Cada término para ALIAS está acordado con la cláusula de salvo imprevistos de mecanización, huelgas, adversidades atmosféricas, causas fortuitas o de fuerza mayor. El cumplimiento de los términos de entrega de los artículos por parte de ALIAS se considera desempeñado cuando ésta los tenga ya listos en la planta para el período acordado, cualquiera que sea el lugar pactado para la entrega. Por lugar de entrega se entiende solamente la planta de producción: cualquier otro acuerdo de entrega en otro lugar y sus formas e intervenciones y otros servicios y prestaciones, se entienden como obligaciones accesorias al contrato fundamental de compraventa. Transcurridos los términos de entrega sin que el Comprador haya recogido la mercancía, ALIAS tiene derecho a actuar según lo indicado en el artículo siguiente. Respecto a los materiales a disposición del Comprador, todo y eventual aplazamiento de la fecha de entrega deberá ser pedida a la sede de ALIAS por escrito por lo menos 30 días antes de la fecha que había sido preestablecida; en todo caso, ALIAS tiene derecho a establecer nuevos términos de entrega, o también de rechazar el aplazamiento del término, con resolución automática de las sucesivas o eventuales obligaciones de contrato.

• **RETRASO EN LA RECOGIDA DE LA MERCANCÍA:** transcurridos 15 días contados a partir de la fecha prevista para la entrega, sin que el Comprador haya cumplido con sus obligaciones en los plazos acordados, aunque no retire la mercancía, los artículos mismos se entenderán, al vencer tal fecha, entregados a todos los efectos, incluso contractuales y de pago, de responsabilidad y riesgo, así como de deterioro, que es daño del Comprador, el cual, a partir de la misma fecha, estará obligado a pagar, además de la cantidad debida, a ALIAS una indemnización por gastos de almacenamiento correspondiente a 10 Euros/pieza/mes.

• **EMPLAZAMIENTO:** si está previsto por contrato, el emplazamiento a cargo de ALIAS debe entenderse como prestación accesoria al contrato de venta de artículos y, en cuanto tal, el Comprador reconoce

que no constituye adjudicación. Deberá ser pedido no más tarde de los dos meses contados a partir de la fecha de entrega de la mercancía, y tendrá lugar compatiblemente con la disponibilidad de la mano de obra por parte del Vendedor en el momento de tal solicitud, sin responsabilidad ninguna del Vendedor en caso de eventuales retrasos. Si el emplazamiento tuviera que ser interrumpido por el Comprador por cualquier motivo, se volverá a a realizar con tiempos y costes por convenir, y en caso de que el Comprador, aun habiendo solicitado el emplazamiento por los motivos citados más arriba, o para acelerar el trabajo, tuviera que recurrir a más personal encargado, previo acuerdo escrito con el Vendedor, a éste no se le presentarán ni gastos de puesta en obra, como previsto en el contrato, ni nada más. El emplazamiento y las obras de construcción que ello conlleva son esenciales para el buen funcionamiento del producto y para la obtención de las prestaciones declaradas. ALIAS hará decaer todas las garantías legales del producto en caso de puesta en obra efectuada por el Comprador directamente o en subcontrato, o de manera disconforme con lo indicado en las instrucciones del producto o, en general, con cuanto dictado por la buena norma técnica del producto. Una vez terminada la puesta en obra realizada por el Vendedor, el Comprador debe presentar por escrito su aprobación al equipo encargado de la obra, con el fin de facilitarle al Comprador el control del trabajo efectuado. En caso de que falte la aprobación de la puesta en obra, el suministro se entenderá aceptado sin reservas por el Comprador. En todo caso, la habilitación del inmueble o la entrega del mismo a terceros se considera expresamente, tanto por el Vendedor, como por el Comprador, como incondicional aceptación del suministro, con la exención de cualquiera otro gasto para el Vendedor.

• **GARANTÍA:** el comitente le otorga al Vendedor todas las tolerancias de uso respecto a las dimensiones y tipologías accesorias. En caso de que la mercancía no pudiera ser utilizada por defectos en el material u otros motivos imputables al Vendedor, y que éste reconozca, éste tiene facultad para sustituirla o para efectuar las eventuales reparaciones, así como para reembolsar el correspondiente precio, con exclusión de la posibilidad del Comprador de pretender indemnizaciones de cualquier tipo, ni siquiera por el retraso por mano de obra, transporte u otros motivos. No se considerarán válidas las reclamaciones que se efectúen de manera diferente de las especificadas en el artículo siguiente. El eventual abono tendrá su curso solamente después de que al Vendedor se le haya restituido la mercancía de que se trate, o de que haya sido sustituida. El Comprador declara a todos los efectos haber examinado la muestra de los productos pedidos, y de haber dado su específica aprobación.

• **RECLAMACIONES Y DERECHO DE RESCISIÓN:** cualquiera que sea su naturaleza y causa, para que las reclamaciones sean válidas se deberán enviar por carta certificada directamente a ALIAS s.r.l., con sede legal y operativa en Via Berlinguer, 22 - Settima di Gossolengo (PIACENZA) en el plazo perentorio de 10 días laborales contados a partir de la entrega de la mercancía pedida.

• **ENVÍO Y TRANSPORTES:** como parte accesoria del contrato de venta, se podrá acordar entre ALIAS y el Comprador el envío de la mercancía por ferrocarril, o por transportista, así como por otros medios puestos por ALIAS. En este caso, queda entendido que la compraventa es independiente del acuerdo indicado anteriormente, y que tal compraventa se entiende ya terminada en el momento en que la mercancía está lista en la planta. Las obligaciones que ALIAS tiene respecto a la conservación de la mercancía y a los tiempos de entrega para su transporte, se terminan en el momento en que la mercancía se carga en los medios puestos por el Comprador, o quien actúe en su nombre o por su cuenta, respecto a la recogida y el transporte, esto es, en el momento en que la mercancía se le entrega al ferrocarril, o al transportista para que se encarguen de su transporte. Si la entrega se realiza por camión articulado no enviado por el Comprador, el transporte se efectuará hasta donde las condiciones de la carretera lo permitan y hasta donde la accesibilidad sea realizable. Ninguna responsabilidad por hechos o retrasos concernientes a envíos por ferrocarril, por transportista o por camiones enviados por el Comprador, o por agentes en nombre y cuenta de éste, podrá ser atribuida a ALIAS. Respecto a los transportes organizados con vehículos de ALIAS, o suministrados por ésta, se entiende que la aceptación de la presente cláusula supone otorgamiento del Comprador a ALIAS para que cumpla las citadas intervenciones. Los materiales de embalaje de madera, caucho, etc. se deberán devolver a ALIAS, a la fábrica de procedencia; en su defecto, se le facturarán al Comprador. A falta de acuerdos precisos respecto a embalajes especiales, el Comprador efectuará los suyos acostumbrados, lo cual se habrá de entender como realizado correctamente en caso de ser aceptado sin reservas por parte del transportista. La mercancía viaja siempre por cuenta, riesgo y peligro del comitente, aunque se haya pactado la entrega en el establecimiento de destino.

• **RESERVA DE PROPIEDAD:** la propiedad de la mercancía se reserva al Vendedor, con expresa prohibición al Comprador de enajenarla antes de que se haya pagado completamente. La mercancía podrá ser reivindicada por el Vendedor en dondequiera que ésta se halle. La falta de pago de un solo plazo causará la resolución del derecho de contrato. Los pagos efectuados irán integralmente a beneficio del Vendedor, en concepto de indemnización, salvo mayores daños, con arreglo al artículo 1525 del Código de lo Civil. A efectos de todo lo anterior, y por cualquier responsabilidad que de ello derive, el Vendedor queda autorizado a dar a conocer al eventual propietario del inmueble, o tercera persona, o persona interesada el contrato y el pacto de reserva de dominio.

• **COMPETENCIA JUDICIAL:** en caso de controversia que derive del presente contrato, así como de su interpretación y ejecución, será competente exclusivo la Autoridad Judicial de Piacenza; esto vale incluso si el pago se ha acordado por medio de letras domiciliadas en sede del deudor. Tal competencia territorial no puede ser derogada, ni siquiera por razones de conexión, comunión o garantía.

• **INFORMATIVA CON ARREGLO AL ART. 13 del D.L. 30.06.2003 n° 196.**

Con arreglo al art. 13 del D.L. 196/2003, ALIAS s.r.l., con sede legal y operativa en la Via Berlinguer, 22 - Settima di Gossolengo (PIACENZA), Titular del tratamiento de datos, le informa que los datos recopilados por ALIAS srl se tratarán electrónicamente para la ejecución de los pedidos o para fines relacionados, así como para elaboración de estadísticas y para iniciativas promocionales y de marketing. La naturaleza del otorgamiento de datos es opcional. Los datos, empero, son necesarios para el desempeño del encargo requerido por el interesado, y sin ellos será imposible desempeñar ninguna actividad a favor del solicitante. El acceso a los datos está permitido a personas encargadas específicamente para ello, como empleados, consultores, terceros proveedores de servicios solamente para los fines indicados anteriormente, esto es, podrán ser comunicados a empresas pertenecientes al ámbito de sociedades de control y controladas. Además, tal y como preceptúan los artículos 7, 8, 9, 10 del D.L. n° 196/2003, cualquier persona interesada puede solicitar en cualquier momento la confirmación de la existencia, modificación o el anulación de sus propios datos, escribiendo al Responsable de la Oficina de Atención al Cliente de ALIAS.



DESIGN SECURITY DOORS